



Innovative UV
Measurement

UV Online Products User's Guide

**EIT Instrument Markets
108 Carpenter Drive
Sterling, VA 20164
Phone: (703) 478-0700
Fax: (703) 478-0815
uv@eit.com
www.eit.com**

EIT Part Number 100200.Online Rev B

Table of Contents

Tables and Figures	iii
List of Tables	iii
List of Figures	iii
1 Introduction	1
2 Compact Sensor™	3
2.1 Compact Sensor™ Accessories and Hardware	4
2.2 Compact Sensor™ Installation	5
2.2.1 Install Mounting Bracket	7
2.2.2 Install Flex Tube for Purge	7
2.2.3 Install Cable	8
2.2.4 Install Compact Sensor™	8
3 DIN Rail UV Intensity Monitor™	10
3.1 DIN Rail UV Intensity Monitor™ Accessories	10
3.2 DIN Rail UV Intensity Monitor™ Installation	10
3.3 DIN Rail UV Intensity Monitor™ Wiring	11
3.3.1 Connect Compact Sensor™ (Required)	13
3.3.2 Connect PLC or Control System (Required)	13
3.3.3 Connect Power Supply (Required)	13
3.3.4 Connect Alarm Relay (Optional)	14
3.3.5 Connect Alarm Setpoint (Optional)	14
3.4 DIN Rail UV Intensity Monitor™ Setup	14
3.4.1 Equipment Warm-up	15
3.4.2 Adjust Intensity Output POT	15
3.4.2 Adjust Alarm Setpoint POT	16
4 Online UV Intensity Display Module™	17
4.1 Online UV Intensity Display Module™ Accessories	17
4.2 Online UV Intensity Display Module™ Installation	18
4.2.1 Enclosed Module Installation	19
4.2.2 Unenclosed Module/Bare PCBA (Printed Circuit Board Assembly) Installation	21
4.2.3 L-Bracket with Enclosed Module Installation	24
4.3 Online UV Intensity Display Module™ Wiring	26
4.3.1 Connect Compact Sensor™ (Required)	27
4.3.2 Connect Power Supply (Required)	27
4.3.3 Connect Terminal Strip (Optional)	27
4.4 Online UV Intensity Display Monitor™ Setup	28
4.4.1 Equipment Setup	28
4.4.2 Adjust UV Intensity Baseline	28
4.4.3 Adjust Alarm Threshold	30
5 Multibrite®	32
5.1 Multibrite® Accessories	32
5.2 Multibrite® Installation	33
5.3 Multibrite® Configuration	34
5.3.1 Intensity, Voltage, and Current Output Range	34
5.3.2 Time Delay Switch Configuration	36
5.3.3 Multibrite® Display Selection	36
5.3.4 Audible Alarm	37
5.3.5 Channel Standby	37
5.4 Multibrite® Wiring	37
5.4.1 Terminal Block 1	37
5.4.2 Terminal Block 2	38
5.4.3 Terminal Block 3	40
5.4.4 Terminal Block 4	42
5.4.5 Install Terminal Blocks in Strain Relief Shells	43
5.4.6 Install Terminal Blocks	45

5.4.7	Connect Compact Sensors™	45
5.5	Multibrite® Setup	46
5.5.1	Equipment Setup	46
5.5.2	Adjust UV Intensity Baseline	46
5.5.3	Set Alarm Threshold	47
Appendix A – EIT UV Bandwidth Definition		48
Appendix B – Compact Sensor™ Technical Specifications		49
Appendix C – DIN Rail UV Intensity Monitor™ Technical Specifications		50
Appendix D – Online UV Intensity Display Module™ Technical Specifications		51
Appendix E – Multibrite® Technical Specifications		52

Tables and Figures

List of Tables

Table 1: EIT Online Products.....	2
Table 2: Compact Sensor™ Supplied and Optional Hardware	4
Table 3: DIN Rail UV Intensity Monitor™ Accessories	10
Table 4: DIN Rail UV Intensity Monitor™ Terminals.....	12
Table 5: Online UV Intensity Display Module™ Accessories and Hardware.....	17
Table 6: Online UV Intensity Display Module™ Terminals	28
Table 7: Multibrite® Supplied Hardware.....	33
Table 8: Multibrite® Intensity, Voltage, and Current Output Range.....	35
Table 9: Time Delay Switch Values in Seconds	36
Table 10: Multibrite® Terminal Block 1.....	37
Table 11: Multibrite® Terminal Block 2.....	39
Table 12: Multibrite® Terminal Block 3.....	40
Table 13: Multibrite® Terminal Block 4.....	42

List of Figures

Figure 1: Compact Sensor™ Models	3
Figure 2: Compact Sensor™ Configurations	4
Figure 3: Sample Lockout Tags.....	6
Figure 4: Compact Sensor™ L-Bracket.....	7
Figure 5: CS-1 Compact Sensor™ with L-Bracket.....	7
Figure 6: CS-2 Compact Sensor™ with L-Bracket.....	7
Figure 7: CS-1 Compact Sensor™ with Purge and Flex Tube	7
Figure 8: CS-1 Compact Sensor™ without Purge Fitting.....	7
Figure 9: Compact Sensor™ with Cable.....	8
Figure 10: Compact Sensor™ Mounting Locations	8
Figure 11: CS-2 Mounted Behind Reflector.....	9
Figure 12: CS-2 with Thermocouple Mounted Behind Reflector	9
Figure 13: CS-2 Mounted on Fixture with Spot Source Light Guide	9
Figure 14: CS-1 Used with Quartz Rod	9
Figure 15: DIN Rail UV Intensity Monitors™ Mounted on "G" Type DIN Rail	10
Figure 16: DIN Rail UV Intensity Monitor™ Terminal Label	11
Figure 17: Multiple Monitors, each with a connection to a separate Compact Sensor™	12
Figure 18: Compact Sensor™ Cable for DIN Rail UV Intensity Monitor™	13
Figure 19: DIN Rail UV Intensity Monitor™ Alarm and Intensity Adjust POTS.....	15
Figure 20: DIN Rail UV Intensity Monitor™ UV Intensity and Alarm Threshold Adjustment	16
Figure 21: Online UV Intensity Display Module™ and Compact Sensor™	17
Figure 22: Enclosed Module "A" Cut Lines and Drill Holes	19
Figure 23: Enclosed Module Installation Mechanical Drawing	20
Figure 24: Online UV Intensity Display Module™ Mounting Studs	20
Figure 25: Unenclosed Module "B" Cut Lines and Drill Holes	21
Figure 26: Unenclosed Module Installation Mechanical Drawing.....	22
Figure 27: Online UV Intensity Display Module™ without Back Enclosure	23
Figure 28: Online UV Intensity Display Module™ Front Panel and Bezel	23
Figure 29: Unenclosed Module (PCBA) Installation	24
Figure 30: Online UV Intensity Display Module™ L-Bracket Placement	25
Figure 31: Enclosed Module Drill Holes for L-Bracket.....	25
Figure 32: Drill Hole Dimensions for L-Bracket.....	26
Figure 33: Enclosed Module Connected to Sensor and Power.....	27

Figure 34: Online UV Intensity Display Module™ Intensity Adjustment	29
Figure 35: Online UV Intensity Display Module™ 100% UV Intensity	29
Figure 36: Online UV Intensity Display Module™ UV Intensity Over Range Condition	29
Figure 37: Online UV Intensity Display Module™ Alarm Threshold Adjustment	30
Figure 38: Online UV Intensity Display Module™ Alarm Threshold Value	30
Figure 39 : Multibrite® with Four Compact Sensors™	32
Figure 40: Multibrite® Top View Dimensions	34
Figure 41: Multibrite® Front View Dimensions	34
Figure 42: Multibrite® Top and Back Cover Screws.....	35
Figure 43: Multibrite® Intensity and Voltage Output Adjustment Switches	35
Figure 44: Multibrite® Back Panel	36
Figure 45: Multibrite Front Panel	36
Figure 46: Multibrite® Integrated Alarm Configuration	40
Figure 47: Terminal Block 3 Wiring Diagram	41
Figure 48: Terminal Block 4 Wiring Diagram	43
Figure 49: Terminal Block in Strain Relief Shell	44
Figure 50: Strain Relief Clamp.....	44
Figure 51: Strain Relief Shell Top.....	44
Figure 52: Strain Relief Shell with Shield.....	44
Figure 53: Labeled Strain Relief Shells	44
Figure 54: Multibrite® with Compact Sensors™ and Terminal Blocks	45
Figure 55: Compact Sensors™ Labeled with Channel Numbers	46
Figure 56: Display Selection for Channel 1	46
Figure 57: Channel 1 100% Baseline Calibrate POT	47
Figure 58: Low Level Threshold	47

1 Introduction

EIT's Online family of products provides continuous observation and monitoring of UV industrial applications. The Online products can be used in conjunction with an EIT Radiometer when continuous monitoring is critical or by themselves in applications where an EIT Radiometer cannot easily fit through the equipment. Applications where EIT's sensors are used include web presses, fiber optic draw towers, and fixtures where the UV source is difficult to access.

The readings generated from our Online family are relative intensity values. When a UV lamp is new and the reflector is clean, the UV System is assumed to be performing at peak (100%) intensity. The display can be set to 100% or the output (0-10V and 4-20mA) set to a value that indicates peak performance. Subsequent readings are proportional to the UV energy at 100% lamp efficiency. An EIT Radiometer may be used in conjunction with the Online products to verify irradiance in watts or energy density in joules.

EIT's Online products observe UV intensity, display the intensity readings from one to four UV sources, trigger alarms based on user-defined low limit thresholds, and output a signal that can be interfaced with a PLC or other type of controller. These products include the:

- Compact Sensor™
- DIN Rail UV Intensity Monitor™
- Online UV Intensity Display Module™
- Multibrite®

Compact Sensor™

The EIT Compact Sensor™ is a durable, stable, long-lasting sensor that is extremely resistant to solarization. (Solarization is a phenomenon where materials change after exposure to UV.) The Compact Sensor™ receives UV through an optic window and generates a small electrical signal relative to the intensity of the UV source. This electrical signal is monitored and/or displayed by the DIN Rail UV Intensity Monitor™, Online UV Intensity Display Module™, or Multibrite®.

DIN Rail UV Intensity Monitor™

The DIN Rail UV Intensity Monitor™ is designed to monitor a single UV source. This product receives an intensity signal from the Compact Sensor™ and outputs a 0-10V proportional to the UV intensity. This allows the DIN Rail UV Intensity Monitor™ to be integrated into control systems with analog signal processing and shared display capabilities. An alarm relay circuit allows the DIN Rail UV Intensity Monitor™ to switch in a user-designed alarm circuit when the signal drops below the set point.

Online UV Intensity Display Module™

EIT's Online UV Intensity Display Module™ is designed to monitor and display a single UV source. This product receives an intensity signal from the Compact Sensor™ and displays the intensity relative to a pre-set 100% intensity. The Online UV Intensity Display Module™ also provides the option to monitor an output signal (0-10V) that is proportional to the UV intensity. This allows the UV Intensity Display to be integrated into control systems with analog signal processing and shared display capabilities. The signal is also compared to a user-defined low level threshold. When the signal is below the threshold, a red low level warning indicator is lit. Two alarm relays allow the module to switch in two user-designed alarm circuits. When the signal is above the low level threshold, the green "above threshold" indicator is visible.

Multibrite®

The Multibrite® is designed to monitor up to four UV sources simultaneously and sound an alarm when any of the four lamps fall below a user-defined threshold. The Multibrite® processes the intensity signal from one to four Compact Sensors™. A switch on the front panel allows the user

to select one of the four signals or the low level threshold for display. By rotating the switch, the user can compare output from the four UV sources. If any of the four intensity signals drop below the threshold, an alarm sounds and a red alarm indicator is visible. A 0-10 volt (V) and a 4-20 milliamp (mA) output signal is generated for each Compact Sensor™ intensity signal. These output signals can be interfaced to a PLC or other control system.

Table 1 summarizes the features of each product.

Table 1: EIT Online Products				
Product	Observe UV Intensity	Display/Monitor Relative Intensity	Output Intensity Signal	Trigger Alarm
Compact Sensor™	One UV Source	NA	–	NA
DIN Rail UV Intensity Monitor™	NA	One UV Source	0-10V Analog	One UV Source
Online UV Intensity Display Module™	NA	One UV Source	0-10V Analog	One UV Source
Multibrite®	NA	One to Four UV Sources or Low Level Threshold (User Selected)	0-10V Analog and 4-20mA per UV Source	One to Four UV Sources The Multibrite® can be linked to additional Multibrite® units for a centralized monitoring and alarm system

2 Compact Sensor™

The Compact Sensor™ is a reliable UV sensor designed to work with the Multibrite®, Online UV Intensity Display Module™, and the DIN Rail UV Intensity Monitor™. The sensor is designed to monitor an intense UV source for thousands of hours without perceptible solarization. The optics on the Compact Sensor™ are sealed to prevent damage from humidity, harmful vapors, and coatings.

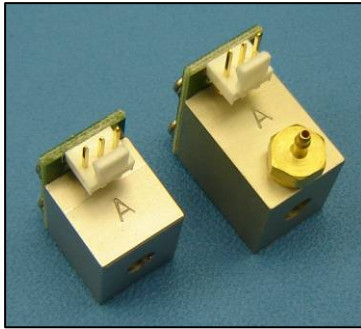

CS-2 Model Shown on Left, CS-1 Model shown on right with purge

Stamped "A" indicates that the Compact Sensor™ is a UVA Sensor

Figure 1: Compact Sensor™ Models

Compact Sensor™ Models

Compact Sensors™ are available in two mechanical models. The CS-1 model has a brass fitting for an air/nitrogen purge assembly and the CS-2 model is supplied without the fitting. The optional purge assembly on the CS-1 model allows a steady stream of oil-free, clean (instrument quality) air or nitrogen to flow over the optics and out the front of the Compact Sensor™. This steady stream of air or nitrogen helps to keep the optical window clean when the Compact Sensor™ is used in a dirty or hostile manufacturing environment. The flow of air or nitrogen can also help to keep the CS-1 model Compact Sensor™ cool. The CS-2 model is slightly smaller and may fit into locations where space is tight. Appendix B provides the dimensions for both models.

Bandwidths

Both models can be supplied in a single EIT bandwidth choice (UVA, UVB, UVC, or UVV). See Appendix A for definition of EIT UVA, UVB, UVC, or UVV bandwidths.

Dynamic Range

EIT's Compact Sensors™ have been successfully used on high power microwave UV sources with thousands of milliwatts of UV output, arc lamp systems with hundreds to thousands of milliwatts of UV output, and on low power UV sources with tens of milliwatts of UV output. EIT Compact Sensors™ can be ordered in three different "Dynamic Range" versions.

To determine which Dynamic Range is needed in your application, consider the power/output rating of the UV source, mounting location and the distance to the UV source. A Compact Sensor™ with a small aperture is best for intense, high power sources including microwave powered UV sources. Sensors that are mounted in a system that are less powerful and/or further away from the source may need slightly more UV light and a slightly larger aperture. Applications with very low levels of UV light may want to consider using a Compact Sensor™ without an aperture. Please contact EIT or your local representative/distributor for more information.

Figure 2 lists the available configurations for both Compact Sensor™ models.

CS-1 Compact Sensor with Purge				Dynamic Range	CS-2 Compact Sensor without Purge			
UVA	UVB	UVC	UVV		UVA	UVB	UVC	UVV
CSA-1-X P/N 92604-2	CSB-1-X P/N 92604-5	CSCH-1-X P/N 92604-11	CSV-1-X P/N 92604-8	High	CSA-2-X P/N 92604-22	CSB-2-X P/N 92604-25	CSCH-2-X P/N 92604-31	CSV-2-X P/N 92604-28
CSA-1 P/N 92604-1	CSB-1 P/N 92604-4	CSCH-1 P/N 92604-10	CSV-1 P/N 92604-7	Mid	CSA-2 P/N 92604-21	CSB-2 P/N 92604-24	CSCH-2 P/N 92604-30	CSV-2 P/N 92604-27
CSA-1-LP P/N 92604-3	CSB-1-LP P/N 92604-6	NA	CSV-1 -LP P/N 92604-9	Low	CSA-2-LP P/N 92604-23	CSB-2 -LP P/N 92604-26	NA	CSV-2-LP P/N92604-29

Figure 2: Compact Sensor™ Configurations

2.1 Compact Sensor™ Accessories and Hardware

The Compact Sensor™ is delivered with an accessory kit containing an L-shaped bracket, mounting screws, washers, and a 10 foot cable with the appropriate connector for the companion monitoring/alarm product. Optional hardware is available from EIT. Table 2 lists provided and optional hardware. Contact EIT or your distributor for assistance with cable choices.











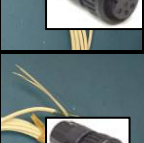

Table 2: Compact Sensor™ Supplied and Optional Hardware			
Hardware	Supplied / Optional	Description	Purpose
	Supplied	L-Bracket	Use as needed to mount Compact Sensor™ to manufacturing equipment.
	Supplied	10-32 0.250L Pan Head Screw	CS-1 MODEL ONLY. Replace the purge fitting with the 10-32 screw when the purge assembly is not in use.
	Supplied	2x 4-40 0.250L Pan Head Screws	CS-1 MODEL ONLY. Mount Compact Sensor™ to manufacturing equipment or attach L-bracket to the Compact Sensor™.
	Supplied	2x M3 x 5 Pan Head Screws	CS-2 MODEL ONLY. Mount Compact Sensor™ to manufacturing equipment or attach L-bracket to the Compact Sensor™.
	Supplied	2x #4 Split Washers	Mount Compact Sensor™ to manufacturing equipment or attach bracket to the Compact Sensor™.

Table 2: Compact Sensor™ Supplied and Optional Hardware			
Hardware	Supplied / Optional	Description	Purpose
Compact Sensor™ is supplied with one of the following two cables.			
	Supplied	CSC1A-10 10' Cable with Molex and BNC Male Connectors	Connect to Online UV Intensity Display Module™ or Multibrite®
	Supplied	CSC1B-10 10' Cable with Molex Connector and Tinned Leads	Connect to DIN Rail UV Intensity Display Monitor™
The following Compact Sensor™ Cables are Optional			
	Optional	CSC1A-X Custom Length Cable with Molex and BNC Male Connectors	Connect to Online UV Intensity Display Module™ or Multibrite®
	Optional	CSC1B-X Custom Length Cable with Molex Connector and Tinned Leads	Connect to DIN Rail Mounted Online UV Intensity Display Module™
	Optional	CSC1D-X Custom length cable with Molex and CONXALL Male Connectors	Used when the cable must fit through a bulkhead or in a system that may be swapped out frequently for maintenance. Molex end connects to the Compact Sensor™.
	Optional	CSC4A-X Custom length cable with CONXALL Female and BNC Male Connectors	Used with the CSC1D-X when installing the cable through a bulkhead and connecting to an Online UV Intensity Display Module™ or Multibrite®.
	Optional	CSC4B-X Custom length cable with CONXALL Female and Tinned Leads	Used with the CSC1D-X when installing the cable through a bulkhead and connecting to a DIN Rail UV Intensity Monitor™.
	Optional	CSC3A-X Custom length cable with BNC Female and BNC Male Connectors	Extension cable for CSC1A-10 or CSC1A-X

2.2 Compact Sensor™ Installation

WARNING: USE EXTREME CAUTION WHEN INSTALLING THE COMPACT SENSOR™. TURN OFF AND LOCK OUT ALL POWER TO THE EQUIPMENT. ALLOW THE EQUIPMENT

Page 5

EIT 108 Carpenter Drive, Sterling, VA 20164 Phone (703) 478-0700
Fax (703) 478-0815 uv@eit.com www.eit.com

TO COOL BEFORE ATTEMPTING THE INSTALLATION. USE LOCKOUT TAGS TO PREVENT INADVERTANT POWER-UP DURING INSTALLATION.



Figure 3: Sample Lockout Tags

MICROWAVE LAMP USERS:

DO NOT ATTEMPT TO CUT INTO THE MICROWAVE LAMP HOUSING. THE LAMP HOUSING CONTAINS THE LAMP, IRRADIATOR, AND MAGNETRON. ALL COMPACT SENSOR™ INSTALLATIONS MUST BE DONE OUTSIDE OF A MICROWAVE LAMP WITH THE SENSOR OBTAINING UV ENERGY OUTSIDE THE RF SAFETY SCREEN.

DO NOT ATTEMPT TO INSTALL THE COMPACT SENSOR™ INSIDE THE MICROWAVE LAMP; THE SENSOR WILL NOT OPERATE PROPERLY AND DAMAGE MAY OCCUR TO THE LAMP. FAILURE TO FOLLOW THESE GUIDELINES MAY RESULT IN RF LEAKAGE.

The Compact Sensor™ can be mounted to view any section of a lamp or reflector. Ideally, the Compact Sensor™ should monitor reflected UV. Due to “hot spots” in a bulb, monitoring the lamp directly is more susceptible to unintended intensity variances. Air flow and equipment vibrations during manufacturing may cause the Compact Sensor™ to move slightly and output changing signals. Reflected UV provides a more even picture of the UV and allows the Online Monitoring System to report intensity changes caused by dirty reflectors and/or aging bulbs. If using quartz plates in your application, mounting the Compact Sensor™ under the plates will also allow the Online System to monitor the condition of the quartz plates as well as the passage of UV through them.

Use the following guidelines to determine the location for installation:

- Position the Compact Sensor™ so that a representative amount of UV light enters the Optic Window. Note the sensor’s angle of view. CS-1 products have a smaller angle of view (5°) than the CS-2 products (13°) due to the longer enclosure. Dimensions and angles of view for both the CS-1 and CS-2 models are provided in Appendix B.
- The Compact Sensor™ and cable must not touch the lamp, lamp cabling, or end caps. If possible, allow at least one inch (2.54 cm) of clearance between the sensor and these areas to prevent arcing or insulation damage.
- The Compact Sensor™ must not be installed in an area where the temperature exceeds 100°C (212°F).
- Keep the Compact Sensor™ cable away from sources of electrical noise.

2.2.1 Install Mounting Bracket

When the Compact Sensor™ cannot be mounted directly on the manufacturing equipment, the L-shaped bracket provided in the accessory kit may be used to position the Compact Sensor™. The CS-1 side of the L-shaped bracket has two #4-40 screw holes positioned 0.375 inches apart and the CS-2 side has two M3x5 screw holes positioned 0.321 inches apart.

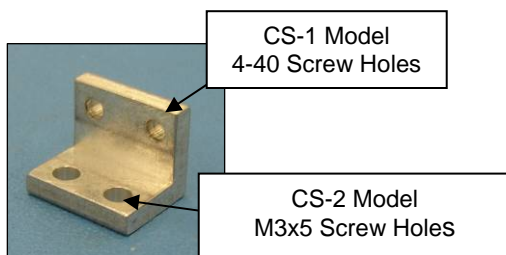

For the CS-1 Compact Sensor™, fit the CS-1 side of the bracket onto the Compact Sensor™ and secure with the two 4-40 screws and two #4 washers provided in the kit. (See Figure 5). For the CS-2 Compact Sensor™, fit the CS-2 side of the bracket onto the compact Sensor™ and secure with the two M3x5 screws provided in the kit. (See Figure 6).

Figure 4: Compact Sensor™ L-Bracket

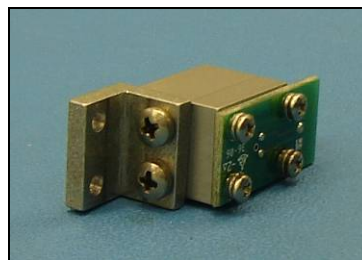
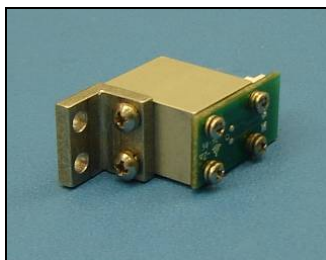

Figure 5: CS-1 Compact Sensor™ with L-Bracket Figure 6: CS-2 Compact Sensor™ with L-Bracket

2.2.2 Install Flex Tube for Purge

If the air/nitrogen purge is to be used, connect it to the sensor's brass fitting using flexible tubing with a 1/16" internal diameter. Only clean air/nitrogen (instrument quality) should be used to avoid depositing any contaminants and/or oil on the sensor. If the air purge is not to be used, remove the fitting and replace it with the #10-32 screw provided in the assembly kit.

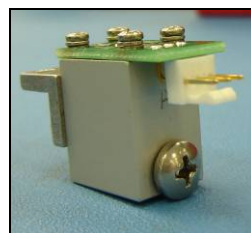
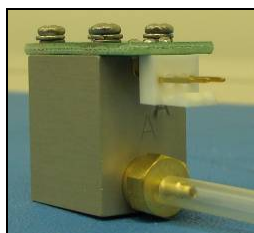

Figure 7: CS-1 Compact Sensor™ with Purge and Flex Tube

Figure 8: CS-1 Compact Sensor™ without Purge Fitting

2.2.3 Install Cable

Connect the Molex connector of the cable to the Compact Sensor™ as shown. Cable selection depends on the companion EIT alarm/monitor product. Contact EIT or your distributor for assistance with cable selection.

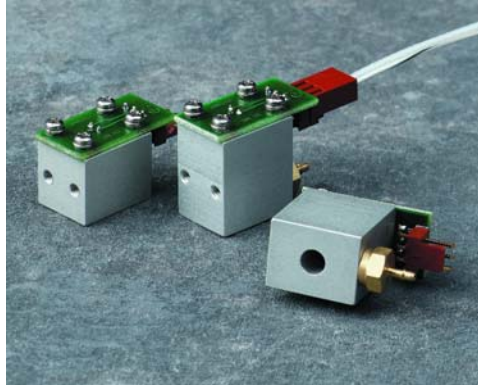

Figure 9: Compact Sensor™ with Cable

2.2.4 Install Compact Sensor™

The following diagram illustrates six possible locations where the Compact Sensor™ may be mounted.

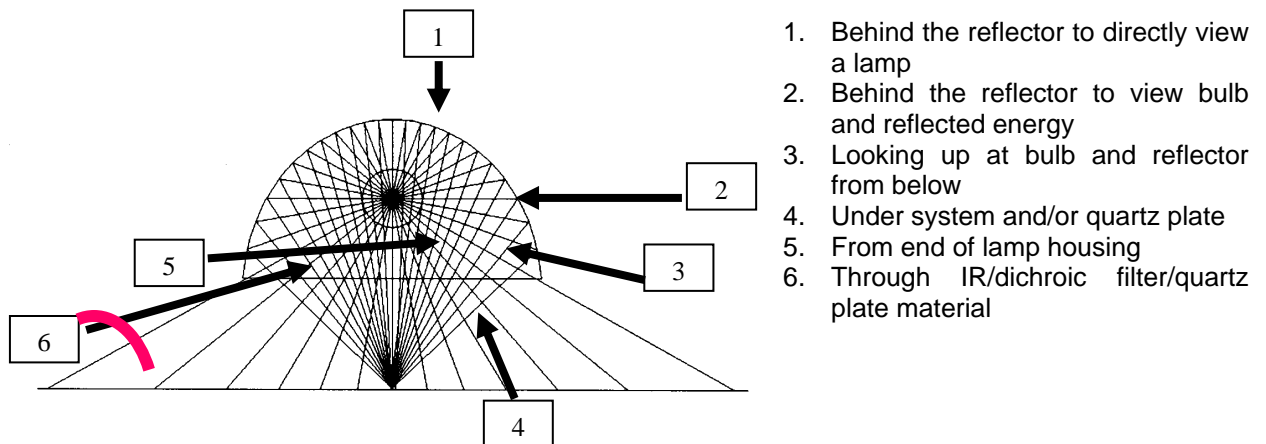

Figure 10: Compact Sensor™ Mounting Locations

Figure 11 shows a CS-2 mounted behind the reflector of a microwave powered lamp. The CS-2 in Figure 12 is using a thermocouple to monitor sensor temperature.

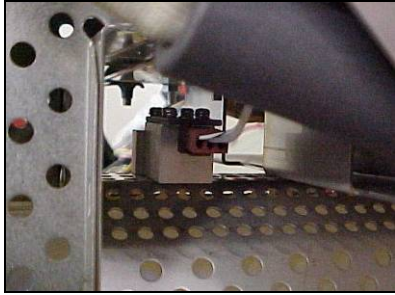

Figure 11: CS-2 Mounted Behind Reflector

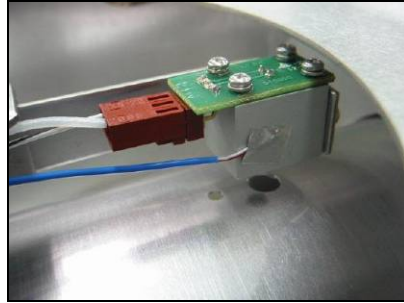

Figure 12: CS-2 with Thermocouple Mounted Behind Reflector

Figure 13 shows a CS-2 mounted in a fixture. This Compact Sensor™ in this example is used to monitor the UV from a UV spot cure source. A portion of the UV is fed through a bi/trifurcated light guide with one leg of the light guide fed into the Compact Sensor™.

Figure 14 shows the use of a CS-1 Sensor with a frosted quartz rod to monitor the UV intensity. The quartz rod is inserted into the optics opening. Use of the quartz rod allows the sensor to pick up UV from a cool location.



Figure 13: CS-2 Mounted on Fixture with Spot Source Light Guide

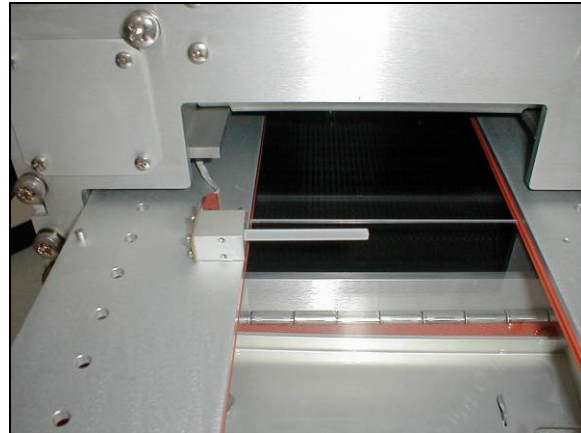



Figure 14: CS-1 Used with Quartz Rod

3 DIN Rail UV Intensity Monitor™

The DIN Rail UV Intensity Monitor™ works with the EIT Compact Sensor™ and a PLC or other Control System to continuously monitor a single UV source. The PLC/Control System must have analog signal processing and display capabilities. During product setup, a 100% UV intensity baseline is established and an alarm threshold is set. The Compact Sensor™ delivers a signal proportional to the UV intensity to the DIN Rail UV Intensity Monitor™. The DIN Rail UV Intensity Monitor™ outputs a 0-10V signal proportional to the intensity of the UV. This value can be displayed on a PLC display or other system. Alarm points can be set and connections can be made to the alarm relay allowing the PLC/Control System to manage the monitor's alarm features.

3.1 DIN Rail UV Intensity Monitor™ Accessories

The DIN Rail UV Intensity Monitor™ is delivered with a screw driver adjustment tool used to adjust the UV Intensity and alarm threshold. See Section 2.1 Compact Sensor™ Accessories for monitor cable options.

Table 3: DIN Rail UV Intensity Monitor™ Accessories		
Hardware	Description	Use
	Screw driver adjustment tool	Adjust UV intensity and alarm threshold

3.2 DIN Rail UV Intensity Monitor™ Installation

The DIN Rail UV Intensity Monitor™ is easy to install. Either a "U" type or "G" type DIN rail purchased from any rail supplier can be used with the monitor. The DIN Rail may be mounted almost anywhere around or on the UV system. The Monitor snaps onto the DIN rail and may be repositioned by sliding it up and down the rail.

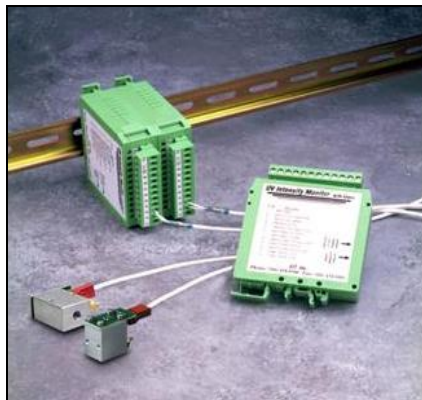

Due to the Monitor's small size, several of them can be installed in a single area. Figure 15 shows two monitors installed on a "G" type rail.

Figure 15: DIN Rail UV Intensity Monitors™ Mounted on "G" Type DIN Rail

Use the following guidelines to install the DIN rail and DIN Rail UV Intensity Monitor™:

- Mount the DIN rail and monitor in an area where the temperature does not exceed 50°C (122°F).
- Even though the DIN Rail UV Intensity Monitor™ has built-in noise rejection, position the monitor to avoid electrical noise.
- Ensure that the Compact Sensor™ cable can reach the monitor and is free from electrical interference. Cable extensions and custom-length cables are available from EIT. (See Section 2.1 Compact Sensor™ Accessories).
- Carefully snap the monitor onto the rail. Once it is attached, slide the monitor along the rail to adjust its position.

3.3 DIN Rail UV Intensity Monitor™ Wiring

WARNING: USE EXTREME CAUTION WHEN INSTALLING THE DIN RAIL UV INTENSITY MONITOR™. TURN OFF ALL POWER. USE LOCKOUT TAGS TO PREVENT INADVERTANT POWER-UP. SEE FIGURE 3 FOR SAMPLE LOCKOUT TAGS.

The DIN Rail UV Intensity Monitor™ must be connected to a Compact Sensor™, a 24V AC or DC power supply, and an integrated monitoring and control system, such as a PLC. The control system must be equipped with analog signal processing and display capabilities. The remaining monitor connections (Alarm Setpoint and Alarm Contact) are optional. To assist with wiring, the monitor label provides a description of each terminal and the terminal strip may be removed and reattached after wiring (See Figure 16).

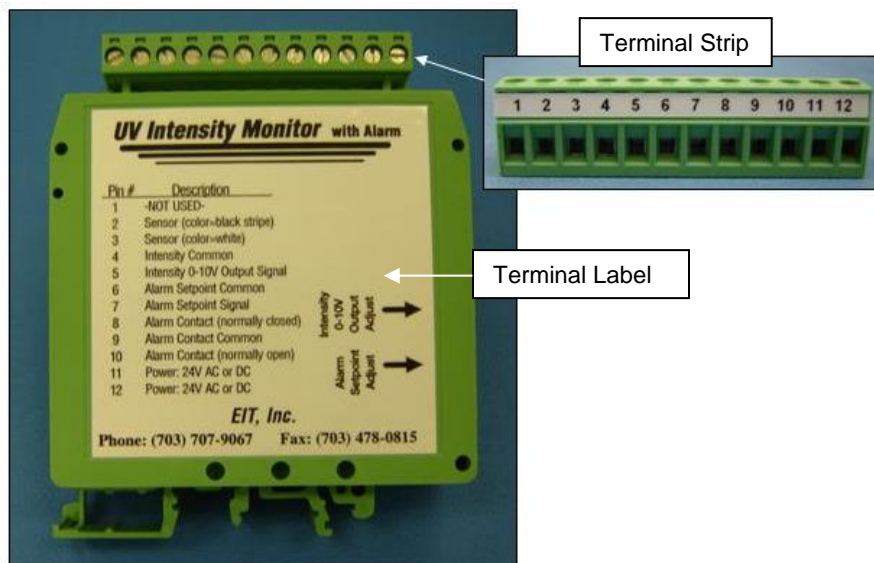

Figure 16: DIN Rail UV Intensity Monitor™ Terminal Label

Table 4 describes the monitor terminals and how they are used.

Table 4: DIN Rail UV Intensity Monitor™ Terminals			
Terminal/ Pin #	Description	Optional/ Required	Use
1	Not Used	-	Not Used
2	Compact Sensor™ White Wire with Black Stripe	Required	Ground connection to Compact Sensor™
3	Compact Sensor™ White Wire	Required	Signal connection to Compact Sensor™
4	Intensity Common	Required	Ground connection to PLC /Control System
5	Intensity 0 to 10 Volt Output Signal	Required	Intensity signal connection to customer's PLC/ Control System
6	Alarm Setpoint Common	Optional	Not Used when PLC or Control System provides alarm recognition
7	Alarm Setpoint Signal	Optional	Not Used when PLC or Control System provides alarm recognition
8	Alarm Contact (Normally Closed)	Optional	Not Used when PLC or Control System provides alarm response
9	Alarm Contact Common	Optional	Not Used when PLC or Control System provides alarm response
10	Alarm Contact (Normally Open)	Optional	Not Used when PLC or Control System provides alarm response.
11	Power: 24V AC or DC	Required	*Power In (+)
12	Power: 24V AC or DC	Required	*Power Out (-)
* Multiple monitors may be "chained" or wired to the same power supply as long as no other common terminals are chained.			

Figure 17 shows installation using multiple Monitors and Compact Sensors™.



Figure 17: Multiple Monitors, each with a connection to a separate Compact Sensor™

3.3.1 Connect Compact Sensor™ (Required)

Connect an EIT Compact Sensor™ to each DIN Rail UV Intensity Monitor™ as follows:

- Sensor ground wire at terminal 2. Figure 17 shows different Compact Sensor™ wire colors for each monitor. When using an EIT Compact Sensor™ Cable, the ground wire is white with black stripes (See Figure 18).
- Sensor signal wire at terminal 3. Figure 17 shows different Compact Sensor™ wire colors for each monitor. When using an EIT Compact Sensor™ Cable, the signal wire is white (See Figure 18).

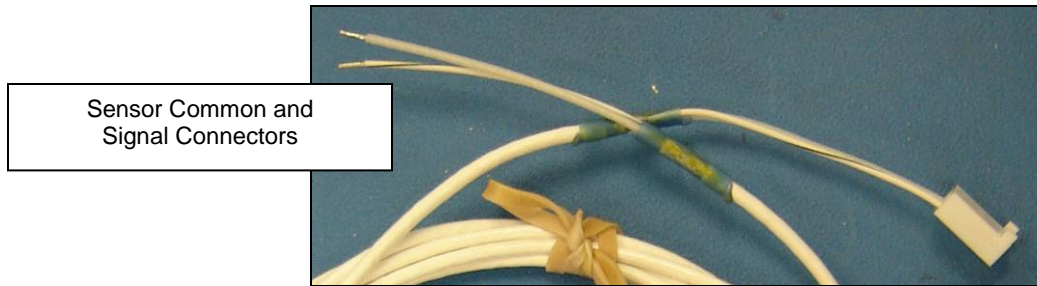

Figure 18: Compact Sensor™ Cable for DIN Rail UV Intensity Monitor™

3.3.2 Connect PLC or Control System (Required)

The PLC or Control System must have analog signal processing and display capabilities. Connect the PLC/control system to the monitor as follows:

- PLC/Control System ground wire at terminal 4. Figure 17 shows a grey ground wire for each monitor.
- PLC/Control System intensity signal wire at terminal 5. Figure 17 shows a black signal wire for each monitor.

DO NOT CHAIN THE INTENSITY SIGNAL GROUND TERMINAL IF USING A COMMON POWER SUPPLY FOR ALL MONITORS OR CHAINING ANY OTHER GROUND TERMINALS.

3.3.3 Connect Power Supply (Required)

The DIN Rail UV Intensity Monitor™ can operate within a range of 20-28 Volts AC or DC. Connecting to voltages greater than 28 will destroy the monitor and void any and all warranty claims.

EIT INC IS NOT RESPONSIBLE FOR ANY DAMAGES OR INJURY RESULTING FROM IMPROPER POWER SUPPLY CONNECTIONS OR IMPROPER VOLTAGES.

Connect the Power Supply to the DIN Rail UV Intensity Monitor™ as follows:

- Power in (+) at terminal 11
- Power out (-) at terminal 12

The power supply may serve multiple monitors by “chaining” the Power In and Power Out terminals. Figure 17 shows Power In (+) and Power Out (-) wiring from the power supply to the left monitor. Power is “chained” to the adjacent monitors.

DO NOT USE A COMMON POWER SUPPLY FOR MULTIPLE MONITORS IF YOU ARE CHAINING ANY OTHER GROUND TERMINALS.

3.3.4 Connect Alarm Relay (Optional)

The DIN Rail UV Intensity Monitor™ compares the UV intensity from the Compact Sensor™ to a preset low level threshold. An alarm relay is activated and a red LED becomes visible when the UV intensity drops below the threshold. This relay can be integrated with a PLC or Control System by connecting the following monitor terminals to the PLC/Control System:

- Alarm Relay Normally Open (terminal 8)
- Alarm Relay Common (terminal 9)
- Alarm Relay Normally Closed (terminal 10)

THE ALARM RELAY CONTACTS ARE NOT RATED FOR CAPACITIVE OR INDUCTIVE LOADS. USE AN INTERPOSING RELAY WITH APPROPRIATE ARC AND ENERGY SUPPRESSION FOR CAPACITIVE OR INDUCTIVE LOADS.

DO NOT CHAIN THE ALARM COMMON TERMINAL IF USING A SINGLE POWER SUPPLY FOR MULTIPLE MONITORS OR CHAINING ANY OTHER GROUND TERMINALS.

3.3.5 Connect Alarm Setpoint (Optional)

The Alarm Setpoint is used to establish the low level threshold for a monitor's alarm relay. This threshold may be set manually on the DIN Rail UV Intensity Monitor™ or programmatically through a PLC or other Control System. To use a PLC or Control System to manage the alarm threshold, connect the following monitor terminals to the PLC/Control System:

- Alarm Setpoint Common (Terminal 6)
- Alarm Setpoint Signal (Terminal 7)

DO NOT CHAIN THE ALARM SETPOINT COMMON TERMINAL IF USING A SINGLE POWER SUPPLY FOR MULTIPLE MONITORS OR CHAINING ANY OTHER GROUND TERMINALS.

3.4 DIN Rail UV Intensity Monitor™ Setup

Once the DIN Rail UV Intensity Monitors™ and Compact Sensors™ are installed, the UV Intensity 100% Baseline and Alarm Threshold are set. The voltage representing 100% efficiency is application specific. For example, if a system requires a 5V 100% UV output voltage, the 100% efficiency baseline is set at 5V. The monitor's 100% output may be set between 0 and 13 volts. The UV Intensity baseline is set by adjusting the Intensity Output Adjust POT or programmatically through the PLC or Control System. Figure 19 shows the monitor's alarm setpoint and output intensity adjustment POTs.



Figure 19: DIN Rail UV Intensity Monitor™ Alarm and Intensity Adjust POTS

3.4.1 Equipment Warm-up

FOLLOW THESE STEPS BEFORE SETTING THE BASELINE VALUE OR ALARM THRESHOLD:

- Replace the existing UV lamps with new lamps and clean the reflectors. This allows the Compact Sensors™ to observe the lamp operating at its peak intensity.
- Turn on power to the UV lamps and DIN Rail UV Intensity Monitors™ and allow the UV lamps to warm up and stabilize for 15 to 30 minutes.

3.4.2 Adjust Intensity Output POT

To set the 100% baseline, follow these steps:

- Place a multimeter on terminals 4 (Intensity Common) and 5 (Intensity 0-10V Output Signal). See Figure 20.
- Use the screwdriver adjustment tool to adjust the Intensity 0-10V Output Adjust POT until the voltmeter reads the required voltage (0-10V). This represents the 100% output point. The DIN Rail UV Intensity Monitor can output a voltage up to 13V. This allows identification of power spike or an unusually bright lamp. If necessary, readjust the UV Intensity POT to represent 100% output.



Figure 20: DIN Rail UV Intensity Monitor™ UV Intensity and Alarm Threshold Adjustment

If the output voltage cannot be adjusted to the desired value, the amount of light observed by the Compact Sensor™ must be increased or decreased. Move the Compact Sensor™ closer or farther away from the UV source or adjust the power supply of the UV system. If moving the Compact Sensor is not possible or other options are not successful, contact EIT or your Distributor for assistance.

3.4.2 Adjust Alarm Setpoint POT

The DIN Rail UV Intensity Monitor™ design incorporates noise immunity around the alarm threshold to prevent constant on/off alarm conditions when the relative intensity is near the low level threshold. The alarm is triggered when the UV intensity drops between 5 and -5 points of the alarm threshold.

Follow these steps to adjust the alarm setpoint:

- Place a multimeter at terminals 6 (Alarm Setpoint Common) and 7 (Alarm Setpoint Signal). See Figure 20.
- Adjust the Alarm Setpoint Adjustment POT until the multimeter reads the desired voltage. Selection of the Alarm Setpoint is dependent on the application's lamp conditions that could cause an undesirable product. Figure 20 shows the Alarm Setpoint set at 70.1. The alarm will be triggered when the UV intensity reaches a value between 65.1 and 75.1.
- To verify the Alarm Threshold, lower the Intensity Output until it is lower than the Alarm Threshold plus or minus the noise immunity. The alarm LED should light. RETURN THE INTENSITY OUTPUT TO THE CORRECT VALUE.

If you experience difficulty with the UV Intensity or Alarm Threshold adjustments, please contact EIT or your local representative/distributor for more information.

4 Online UV Intensity Display Module™

EIT's Online UV Intensity Display Module™ works in combination with a Compact Sensor™ to monitor and display the intensity from a single UV source. During product setup, a 100% UV intensity baseline is established and an alarm threshold is set. The Compact Sensor™ delivers a signal proportional to the UV intensity Display Module. The Module displays the relative signal and also has the option to output a 0-10 volt signal, in the same manner as the DIN Rail UV Intensity Monitor™. Alarm conditions can be set to show on the Display Module. Alarm relays can be set to trigger when the signal falls below the user set point.

The Online UV Intensity Display Module™ is intended for applications requiring a front panel display. Cutouts for the monitor are easily made in a UV curing system's control panel or the module may be installed onto the control panel using L-shaped brackets provided in the hardware kit. One Online UV Intensity Display Module™ and one Compact Sensor™ are installed for each lamp in the application.



Figure 21: Online UV Intensity Display Module™ and Compact Sensor™

4.1 Online UV Intensity Display Module™ Accessories

The Online UV Intensity Display Module™ is delivered with an assembly kit and a hardware kit. The assembly kit contains a drill template and a screw driver adjustment tool. The hardware kit contains L-shaped brackets, screws, washers, and hex nuts used to mount the module onto the control panel. Table 5 provides a description of each item in the accessory and hardware kits.





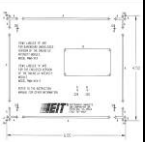

Table 5: Online UV Intensity Display Module™ Accessories and Hardware		
Hardware / Accessory	Description	Use
	2x L-shaped Brackets	Attach the monitor to the bottom, top, or side of the control panel.

Table 5: Online UV Intensity Display Module™ Accessories and Hardware		
Hardware / Accessory	Description	Use
	4x #6 Flat Washers	Install the monitor directly onto the control panel or to attach the monitor onto the bottom, top, or side of the control panel using the L-shaped brackets.
	4x #6 Lock Washers	Install the monitor directly onto the control panel or to attach the monitor onto the bottom, top, or side of the control panel using the L-shaped brackets.
	4x #6-32 Hex Nuts	Install the monitor directly onto the control panel or to attach the monitor onto the bottom, top, or side of the control panel using the L-shaped brackets.
	2x #6-32 x 0.600L Pan Head Screws	Attach the L-shaped bracket to the top, bottom, or side of the control panel.
	Drill Template	Use the template to mark the cutout and drill holes needed to install the monitor.
	Screw Driver Adjustment Tool	Adjust UV intensity and alarm threshold.

4.2 Online UV Intensity Display Module™ Installation

WARNING: USE EXTREME CAUTION WHEN INSTALLING THE ONLINE UV INTENSITY DISPLAY MODULE™. TURN OFF ALL POWER. USE LOCKOUT TAGS TO PREVENT INADVERTANT POWER-UP. SEE FIGURE 3 FOR SAMPLE LOCKOUT TAGS.

EIT's Online UV Intensity Display Module™ may be mounted anywhere on the curing system's control panel. Use these guidelines to determine the location for installation:

- Select an area where the temperature does not exceed 50°C (122°F).
- Even though the Online UV Intensity Display Module™ has built-in noise rejection, position the module to avoid electrical noise.
- Ensure that the Compact Sensor™ cable can reach the module and is free from electrical interference. Cable extensions and custom-length cables are available from EIT. (See Section 2.1 Compact Sensor™ Accessories).

The Online UV Intensity Display Module™ is delivered with a front and back enclosure. The module may be installed in the curing system's control panel with or without the enclosure. Both methods require creating a cutout in the control panel. The L-shaped brackets from the hardware kit allow the enclosed module to be attached to the top, bottom, or side of the control panel

without creating a cutout. The following sections provide instructions for all three installation methods.

4.2.1 Enclosed Module Installation

To install the enclosed module, a 4.12" x 5.62" rectangle and four 0.144" diameter screw holes are cut from the control panel. EIT provides a cut and drill template (part number 92332A) in the accessory kit (See Figure 22). Figure 23 provides the required cutout and drill dimensions.

Create Cutout using Drill Template

- The drill template (part number 92332A) shows cut lines and drill holes marked "A" and "B". USE ONLY THE CUT LINES AND DRILL HOLES MARKED "A". Figure 22 marks the "A" cut lines and drill holes in red.
- Using an Exacto knife or similar tool, open the template's cut lines and drill holes marked "A".
- With masking tape or other means, secure the drill template to the control panel in the location where the module will be installed.
- Mark the cut lines and drill holes onto the control panel.
- Remove the template and verify that the marked cut lines and drill holes are correct.
- Carefully cut the four lines and drill the four screw holes.

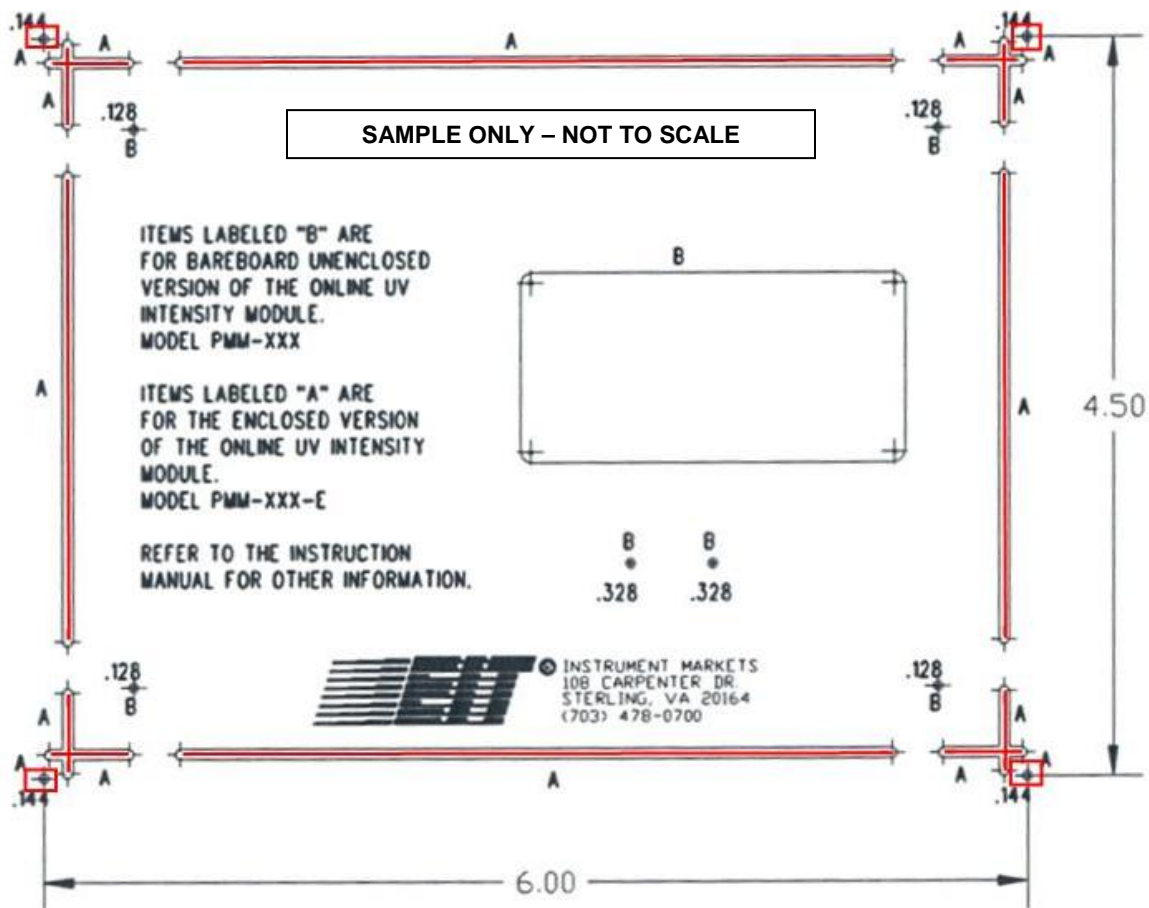

Figure 22: Enclosed Module "A" Cut Lines and Drill Holes

Create Cutout using Mechanical Drawing

- Mark a 4.12" x 5.62" rectangle on the control panel.
- Mark the four 0.144" diameter drill holes.
- See Figure 23 for drill locations and line cutout dimensions.
- Carefully cut the rectangle and drill the screw holes.

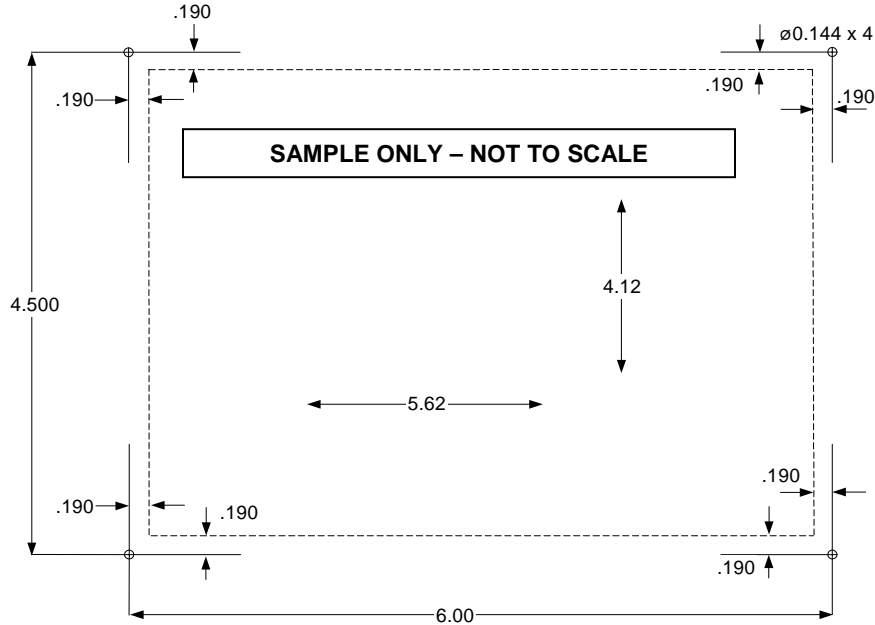

Figure 23: Enclosed Module Installation Mechanical Drawing

Install Module

- Fit the module into the cutout. Make sure the module's four mounting studs fit into the drilled screw holes. Figure 24 shows the mounting studs marked in red.
- Secure the module to the panel using the four #6 Lock Washers, #6 Flat Washers, and #6 Hex Nuts provided in the hardware kit.



Figure 24: Online UV Intensity Display Module™ Mounting Studs

4.2.2 Unenclosed Module/Bare PCBA (Printed Circuit Board Assembly) Installation

USE ESD (Electro Static Discharge) SAFE PROCEDURES INCLUDING A GROUND STRAP WHEN HANDLING THE Online UV Intensity Display Module™ PCBA OUTSIDE OF THE ASSEMBLY HOUSING.

To install the unenclosed PCBA in a control panel, the front and back enclosure must be removed and cutouts for the LCD, two LEDs, and four screws must be cut from the control panel. EIT provides a cut and drill template (part number 92332A) in the accessory kit (See Figure 25). Figure 26 provides the required cutout dimensions.

Create Cutout using Drill Template

- The drill template (part number 92332A) shows cut lines and drill holes marked “A” and “B”. USE ONLY THE CUT LINES AND DRILL HOLES MARKED “B”. Figure 25 marks the cut lines and drill holes in red.
- Using an Exacto knife or similar tool, open the template's cut lines and drill holes marked “B”.
- With masking tape or other means, secure the drill template to the control panel in the location where the module will be installed.
- Mark the cut lines and drill holes onto the control panel.
- Remove the template and verify that the marked cut lines and drill holes are correct.
- Carefully cut through the four lines and drill through the four screw holes and two LED holes.

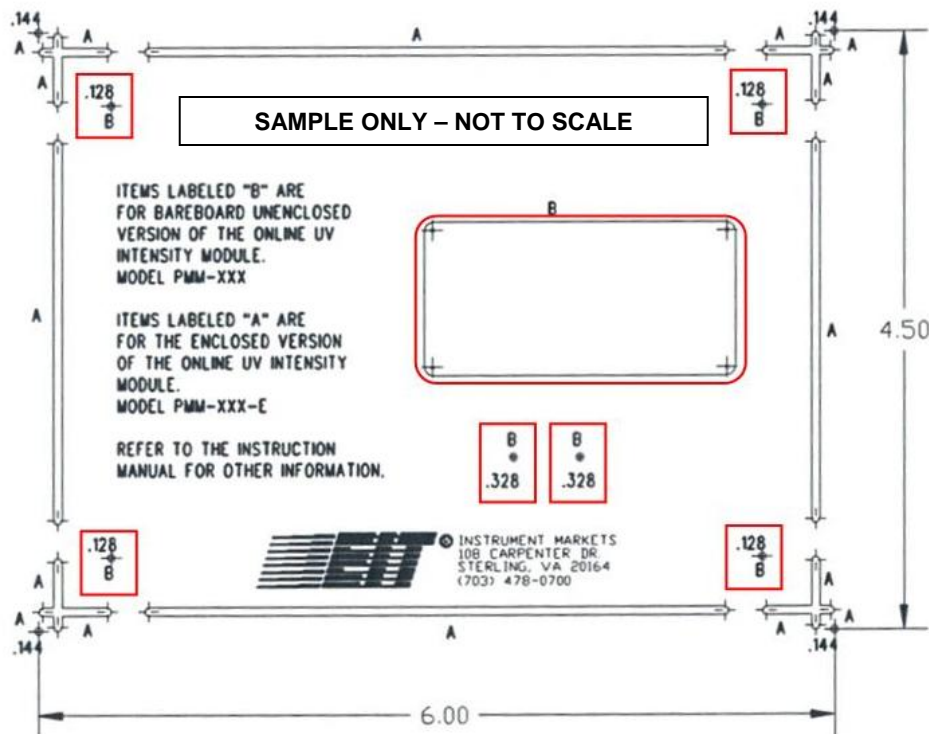

Figure 25: Unenclosed Module “B” Cut Lines and Drill Holes

Create Cutout using Mechanical Drawing

- Mark the LCD cutout using the dimensions in Figure 26.
- Mark the two 0.328" diameter drill holes for the LEDs. See Figure 26 for drill locations.
- Mark the four 0.128" diameter drill holes for the 4-40 screws. See Figure 26 for drill locations.
- Carefully cut the LCD location and drill the LED and screw holes.

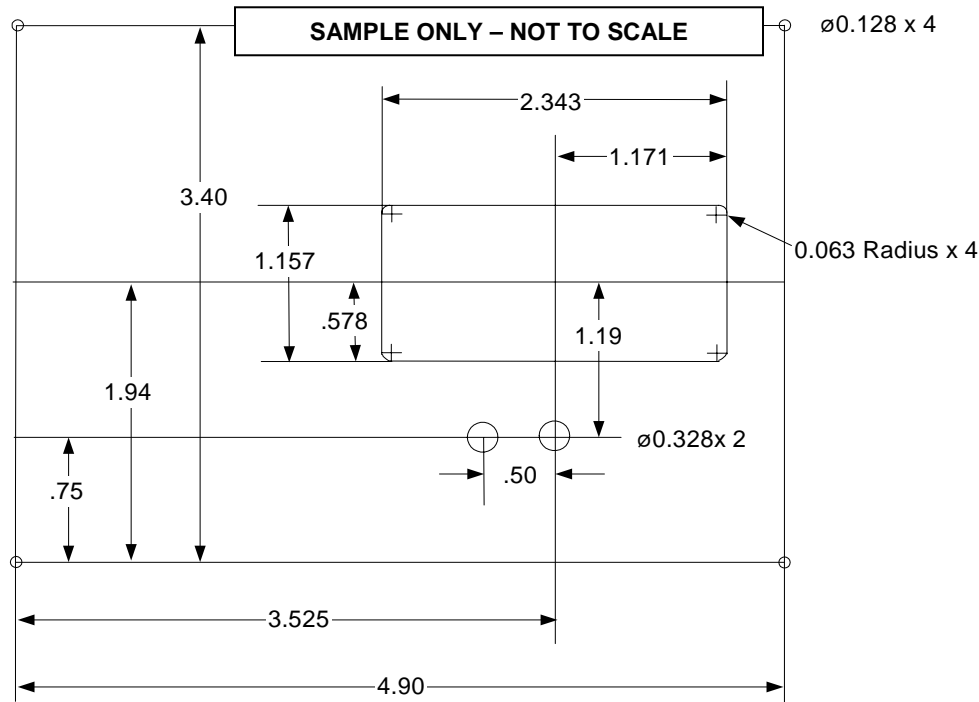

Figure 26: Unenclosed Module Installation Mechanical Drawing

USE ESD (Electro Static Discharge) SAFE PROCEDURES INCLUDING A GROUND STRAP WHEN HANDLING THE Online UV Intensity Display Module™ PCBA OUTSIDE OF THE ASSEMBLY HOUSING.

Remove PCBA from Enclosure

- Remove the back enclosure from the PCBA. RESERVE THE FOUR 4-40 x .250L PAN HEAD SCREWS, FOUR #4 FLAT WASHERS, and FOUR #4 SPLIT WASHERS FOR REINSTALLATION.

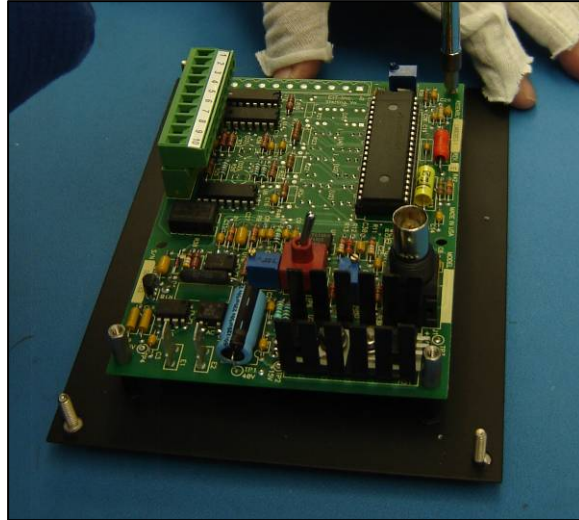

Figure 27: Online UV Intensity Display Module™ without Back Enclosure

- Remove the four standoffs and RESERVE FOR REINSTALLATION.
- Carefully lift the PCBA from the front panel.
- Carefully remove the Bezel with filter from the front panel. Bezel snaps in and must be removed with caution.

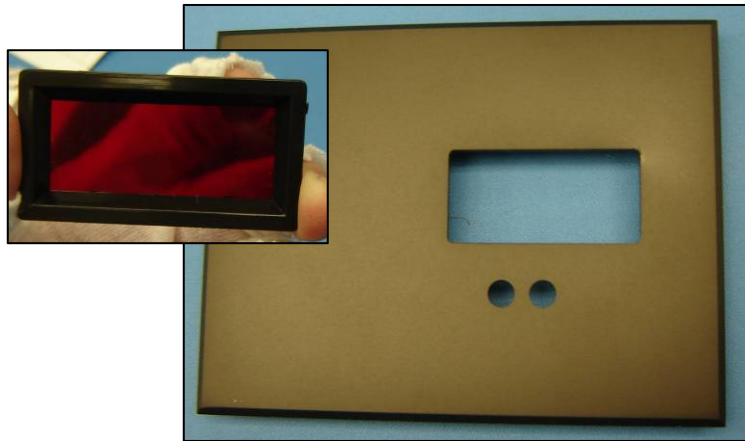

Figure 28: Online UV Intensity Display Module™ Front Panel and Bezel

Install PCBA

- Fit the Bezel into the cutout of the control panel. Bezel should snap into place.
- Using the four 4-40 screws, four split washers, and four flat washers removed above, reinstall the four standoffs to the front side of the PCBA (see Figure 29).
- Fit the PCBA to the control panel. Make sure the LCD fits in front of the Bezel, the two LEDs fit into the cutouts, and the threaded end of the standoffs fit through the four screw holes.

- From outside the control panel, secure the PCBA with four 4-40 x .38LG screws, four #4 flat washers, and four #4 split washers. These components are not included in the hardware kit (see Figure 29).

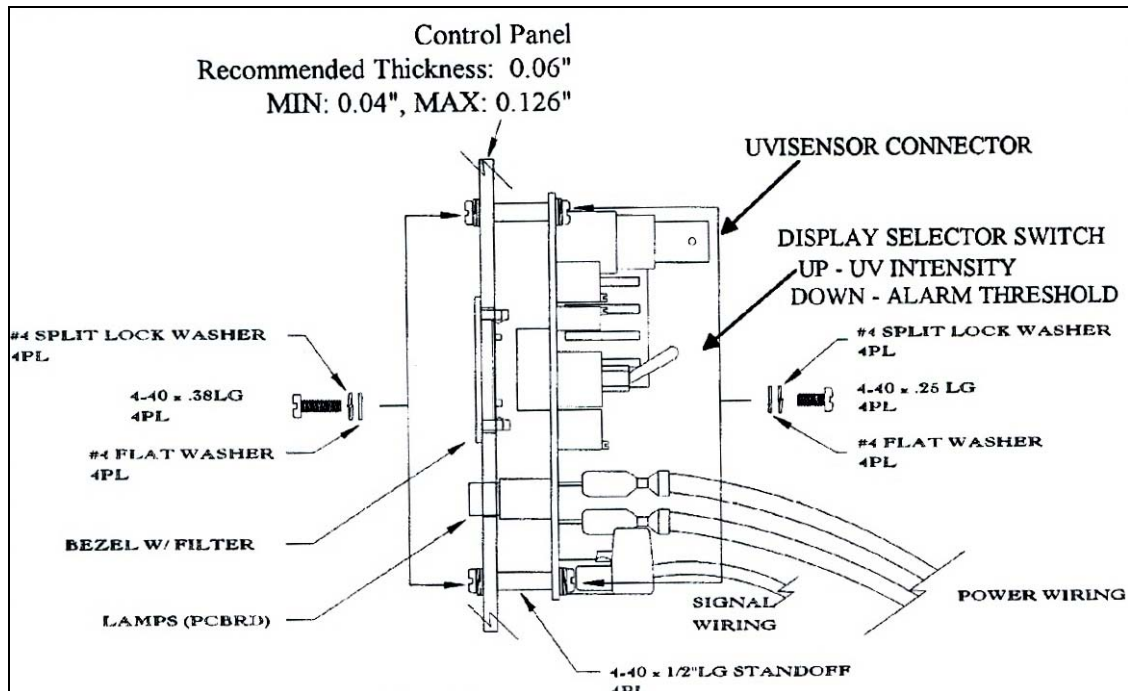

Figure 29: Unenclosed Module (PCBA) Installation

4.2.3 L-Bracket with Enclosed Module Installation

The L-shaped brackets provided in the hardware kit allow the enclosed monitor to be installed on the top, bottom, or side of the control panel. Figure 30 shows sample locations where the module may be installed.

To use the brackets, two 0.144" diameter screw holes must be drilled into the control panel. EIT provides a drill template (part number 92332A) in the accessory kit. Figure 31 provides the required drill locations and dimensions.

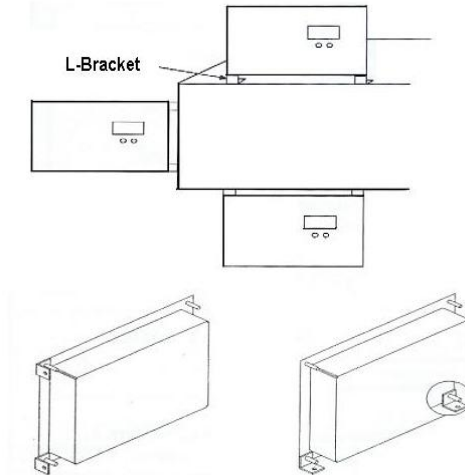

Figure 30: Online UV Intensity Display Module™ L-Bracket Placement

Create Screw Holes using Drill Template

- The drill template (part number 92332A) provides cut lines and drill holes marked “A” and “B”. USE ONLY THE DRILL HOLES MARKED “A”. Figure 31 marks the drill holes in red.
- Based on the installation location, use an Exacto knife or other tool to open two of the four holes marked “A”.
- With masking tape or other means, secure the drill template to the control panel in the location where the module will be installed.
- Mark the drill holes onto the control panel.
- Carefully drill the two 0.144” screw holes.

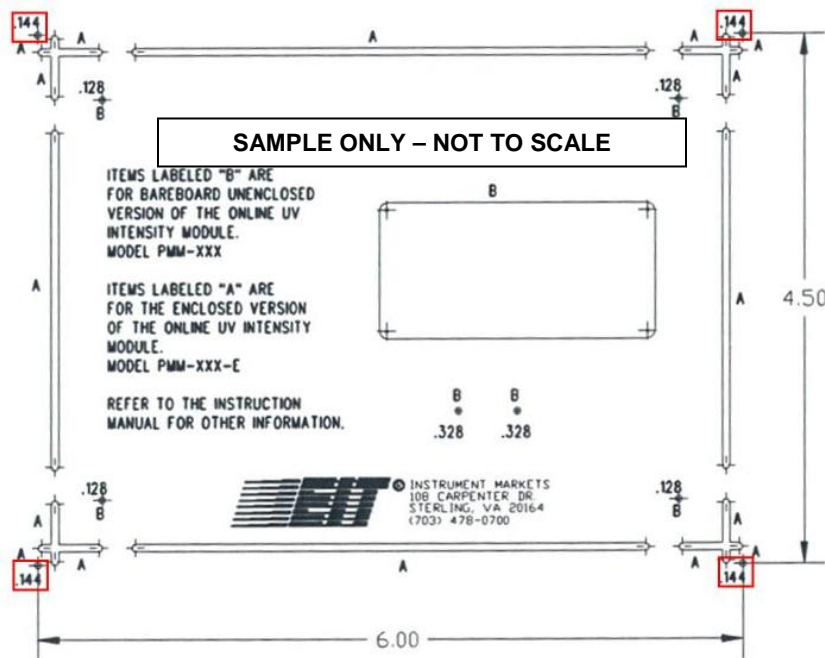

Figure 31: Enclosed Module Drill Holes for L-Bracket

Create Cutout using Mechanical Drawing

- Mark the two 0.144" diameter drill holes. See Figure 32 for drill locations and dimensions.
- Carefully drill the screw holes.

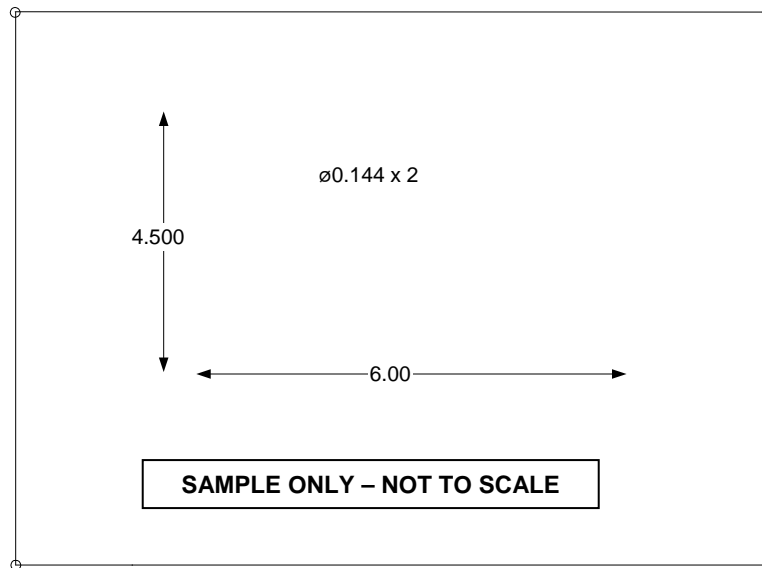

Figure 32: Drill Hole Dimensions for L-Bracket

Install Brackets and Module

- Install the L-shaped brackets onto the control panel using two 6-32 pan head screws, two #6 split washers, two #6 flat washers, and two #6 hex nuts from the hardware kit.
- Fit the module to the brackets. Make sure that two of the modules mounting studs fit through the brackets.
- Secure the module to the brackets using the remaining two #6 split washers, two #6 flat washers, and two #6 hex nuts.

TIP: Install the brackets onto the control panel before mounting the module. The pan head screws are difficult to insert if the bracket is already installed on the module.

4.3 Online UV Intensity Display Module™ Wiring

To operate, the Online UV Intensity Display Module™ must be connected to a Compact Sensor™ and a 24V AD or DC power supply. A terminal strip allows the module to optionally be connected to an integrated monitoring and control system, such as a PLC, and two user-defined alarm systems. The control alarm systems must be cable of processing a 0–10V analog signal. Figure 33 shows the Compact Sensor™ and Power Supply connections as well as the terminal strip.

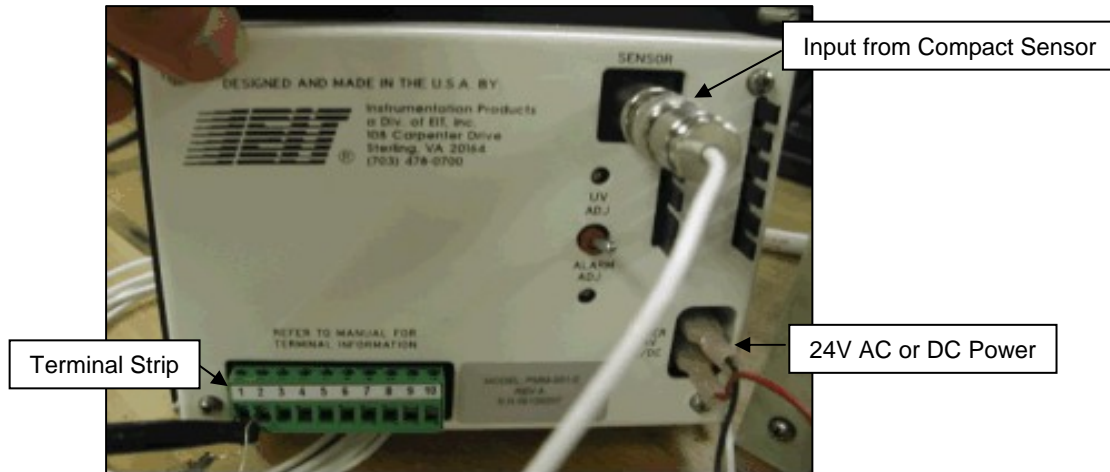

Figure 33: Enclosed Module Connected to Sensor and Power

4.3.1 Connect Compact Sensor™ (Required)

Use a Compact Sensor™ cable with a BNC connector to connect the Compact Sensor™ to the module. A ten foot cable is provided with the Compact Sensor™, but custom lengths or extension cables are available. See Section 2.1 Compact Sensor™ Accessories for Compact Sensor™ cable information.

4.3.2 Connect Power Supply (Required)

The Online UV Intensity Display Monitor™ can operate within a range of 20 - 28 Volts AC or DC. Connecting to voltages greater than 28 will destroy the Module and void any and all warranty claims. Use a power supply with female "Faston" connectors.

EIT INC IS NOT RESPONSIBLE FOR ANY DAMAGES OR INJURY RESULTING FROM IMPROPER POWER SUPPLY CONNECTIONS OR IMPROPER VOLTAGES.

4.3.3 Connect Terminal Strip (Optional)

The monitor's terminal strip allows the monitor to be integrated with a PLC or other Control System and to two user-defined Alarm Systems. The PLC/Control System and Alarm Systems must be capable of processing 0-10V analog signal. To assist with wiring, the terminal strip may be removed and reattached after wiring. Table 6 provides a list of the terminal strip pins.

Table 6: Online UV Intensity Display Module™ Terminals		
Terminal/ Pin #	Description	Use
1	Intensity Common	Ground connection to PLC or other System Control
2	Intensity 0 to 10 Volt Output Signal	Intensity signal connection to PLC / Control System
3	Not Used	Not Used
4	Not Used	Not Used
5	Alarm Relay Contact Normally Open (First Set)	Alarm normally open connection to PLC / Control System
6	Alarm Contact Common (First Set)	Alarm ground connection to PLC / Control System
7	Alarm Relay Contact Normally Closed (First Set)	Alarm normally closed connection to PLC / Control System
8	Alarm Relay Contact Normally Open (Second Set)	Alarm normally open connection to Alarm System
9	Alarm Relay Contact Common (Second Set)	Alarm ground connection to Alarm System
10	Alarm Relay Contact Normally Closed (Second Set)	Alarm normally closed connection to Alarm System

4.4 Online UV Intensity Display Monitor™ Setup

After the Online UV Intensity Display Monitor™ and Compact Sensor™ are installed, the UV Intensity baseline signal (usually 100%) and Alarm Threshold are set. Follow the Equipment Setup procedure before adjusting the UV Intensity Baseline or setting the Alarm Threshold.

4.4.1 Equipment Setup

FOLLOW THESE STEPS BEFORE SETTING THE BASELINE VALUE OR ALARM THRESHOLD:

- Replace the existing UV lamps with new lamps and clean the reflectors. This allows the Compact Sensors™ to observe the lamp operating at its peak intensity.
- Turn on power to the UV lamp and Online UV Intensity Display Monitor™ and allow the UV lamp to warm up and stabilize for 15 to 30 minutes.

4.4.2 Adjust UV Intensity Baseline

To establish the baseline, follow these steps:

- Place the display selector switch in the up (UV ADJ) position. (See Figure 34)

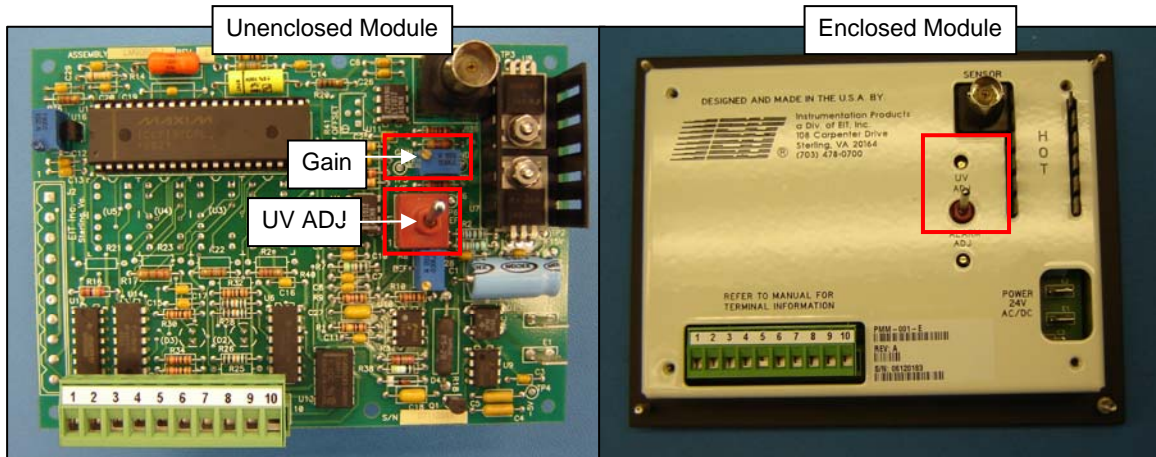

Figure 34: Online UV Intensity Display Module™ Intensity Adjustment

- Use the Screw Driver Adjustment Tool from the accessories kit to adjust the UV ADJ POT (Gain POT on Unenclosed Module) until the display shows 100% (see Figure 35).



Figure 35: Online UV Intensity Display Module™ 100% UV Intensity

Over Range Condition

If the Online UV Intensity Display Monitor™ shows the number 1 to the extreme left with no other digits, the monitor is in an over range condition. Decrease the intensity adjustment by turning the UV ADJ POT counterclockwise. If the monitor continues to show number 1, the Compact Sensor™ is receiving too much UV. If possible, move the Compact Sensor™ further away from the UV lamp. Please contact EIT or your local representative/distributor for more information.



Figure 36: Online UV Intensity Display Module™ UV Intensity Over Range Condition

Under Range Condition

If the Online UV Intensity Display Monitor™ cannot be increased to 100% or is very sensitive to adjustments, the Monitor is in an under range condition. Move the Compact Sensor™ closer to

the monitor or increase the power applied to the lamp. Please contact EIT or your local representative/distributor for more information.

4.4.3 Adjust Alarm Threshold

The Online UV Intensity Display Module™ design incorporates noise immunity around the alarm threshold to prevent constant on/off alarm conditions when the relative intensity is near the low level threshold. The alarm is triggered when the intensity drops between 5 and -5 points of the alarm threshold.

To set the Alarm Threshold, follow these steps:

- Place the display selector in the down (Alarm ADJ) position (see Figure 37).

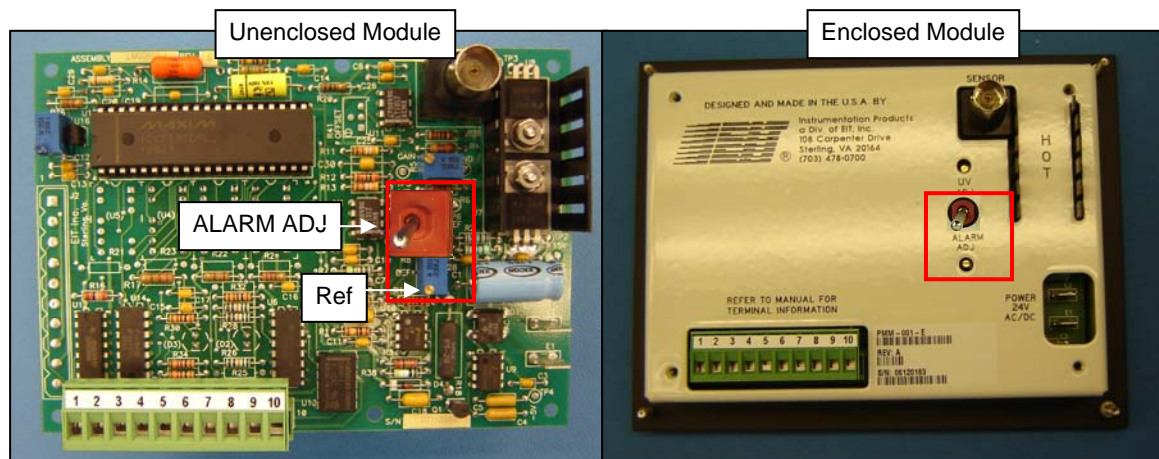

Figure 37: Online UV Intensity Display Module™ Alarm Threshold Adjustment

- When adjusting the alarm threshold, the Online UV Intensity Display Module™ shows a small line in the left side of the LCD and displays the alarm threshold value (see Figure 38).



Figure 38: Online UV Intensity Display Module™ Alarm Threshold Value

- Use the Screw Driver Adjustment Tool from the accessories kit to adjust the ALARM ADJ POT (REF POT on Unenclosed Module) until the module shows the desired

alarm threshold. Figure 38 shows the Alarm Threshold set to 70. The alarm is triggered when the UV Intensity reaches a value between 65 and 75 points.

- To verify the Alarm Threshold, lower the UV Intensity until the alarm LED is lit. The display should show an intensity value between 65 and 75. RETURN THE UV INTENSITY TO THE CORRECT VALUE.

Intensity Common and 0-10V Signal (Optional)

The Online UV Intensity Display Module™ outputs a 0–10 Volt intensity signal proportional to the lamp intensity. This signal may be processed by a PLC or other Control System. Connect the PLC/Control System to the module terminal strip as follows:

- PLC/Control System ground wire at terminal 1.
- PLC/Control System intensity signal wire at terminal 2.

Alarm Relays (Optional)

The Online UV Intensity Display Module™ compares the UV intensity from the Compact Sensor™ to a preset low level threshold. Two alarm relays are activated and a red LED becomes visible when the UV intensity drops below the threshold. Both relays may be integrated with external Alarm Systems. Connect the Alarm Systems to the module terminal strip as follows:

- First Alarm System normally open at terminal 5.
- First Alarm System common at terminal 6.
- First Alarm System normally closed at terminal 7.
- Second Alarm System normally open at terminal 8.
- Second Alarm System common at terminal 9.
- Second Alarm System normally closed at terminal 10.

5 Multibrite®

The Multibrite® is designed to monitor up to four UV sources simultaneously and sound an alarm when any of the lamps falls below a user-defined threshold. All UV sources connected to a Multibrite® must have the same bandwidth (i.e. UVA or UVC). In curing systems with more than four UV sources or where monitoring of different UV bandwidths (i.e. UVA and UVC) is required, multiple Multibrites® can be linked to provide a centralized alarm system. During setup, a low level threshold is set for each Multibrite®. This threshold is applicable to all UV sources connected to the Multibrite®. If any of the intensity signals drop below the threshold, an alarm sounds and a red alarm indicator is visible. When Multibrites® are linked, an alarm is triggered when any of the lamps within the system drops below the preset threshold

Output signals (0-10V and 4-20 mA) are also generated for each Compact Sensor™ intensity signal. These output signals can be interfaced to a PLC or other control system equipped with analog signal processing.





The Multibrite® is available in two models, the Model MB100AC1 for use in 110V environments and the MB240AC1 for use with 220V power.



Figure 39 : Multibrite® with Four Compact Sensors™

5.1 Multibrite® Accessories

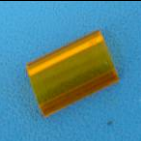
The Multibrite® is delivered with an accessory kit containing four strain relief kits, a screw driver adjustment tool, and four black rubber feet. Table 7 lists each supplied item. Section 2.1 provides available options for Compact Sensor™ cables used with the Multibrite®.

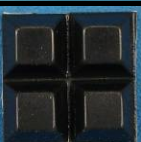
Table 7: Multibrite® Supplied Hardware		
Hardware	Description	Use
	4x Strain Relief Shell	Contained in the Strain Relief Kits. Encloses terminal strips for pullout protection
	4x Strain Relief Clamp	Contained in the Strain Relief Kits. Used with two Flat Head Screws to secure terminal strip to Strain Relief Shell
	4x Strain Relief Shield	Contained in the Strain Relief Kits. Prevents Strain Relief Shell top and bottom from separating
	8x Flat Head Screws	Contained in the Strain Relief Kits. Used with Strain Relief Clamp to secure terminal strip to Strain Relief Shell
	Screw Driver Adjustment Tool	Adjust UV intensity and alarm threshold
	4x Rubber Feet	Prevents Multibrite® from accidentally moving during operation.

5.2 Multibrite® Installation

The Multibrite® offers multiple options for installation. This unit may be wall, panel, or rack mounted or simply set on a surface. Use these guidelines to determine the location for installation:

- Select an area where the temperature does not exceed 50° C (122° F).
- Even though the Multibrite® has built-in noise reduction, position the unit to avoid electrical noise.
- Ensure that the Compact Sensor™ cable(s) can reach the Multibrite® and are free from electrical interference. Cable extensions and custom-length cables are available from EIT. (See Section 2.1 Compact Sensor™ Accessories).

The Multibrite® is designed with ½ rack dimensions and is delivered with a top and back enclosure and a front panel. The total area utilized by the Multibrite® is 9.44 in (23.98 cm) wide x 3.5 in (8.89 cm) high x 8.42 in (21.39 cm) deep. Figure 40 provides the Multibrite® top view dimensions and Figure 41 provides the front view dimensions. When installation space is tight, remove the strain relief shells to reduce the 2.5 inch clearance needed for the I/O Connectors to 1.5 inches.

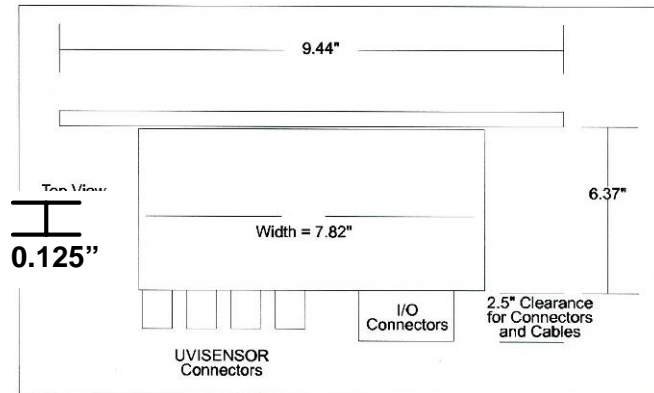

Figure 40: Multibrite® Top View Dimensions

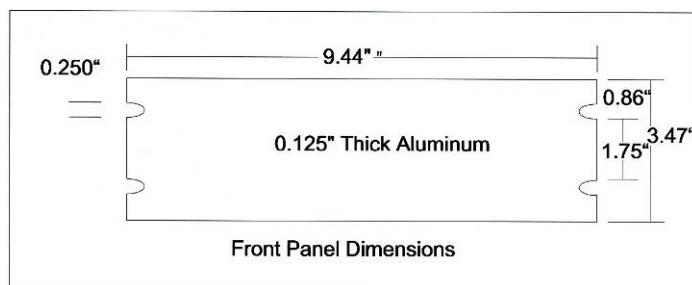

Figure 41: Multibrite® Front View Dimensions

5.3 Multibrite® Configuration

The Multibrite® is easily configurable to meet customer and PLC/Control System requirements. Switches on the Front Panel allow the customer to select one of four intensity signals or the low level threshold for display, place any of the four UV sources (channels 1 – 4) in standby mode, and to disable the audible alarm. Internal switches allow the customer to select an intensity range (0 – 100% or 0 – 200%) and a voltage output range (0 – 10 Volts or 0 – 5 Volts). Time Delay switches on the rear of the Multibrite® allow the customer to define a length of time before the low intensity alarm is triggered. This option allows the UV curing system to power up without triggering a low intensity alarm.

If you have questions on Multibrite® configuration, please contact EIT or your local distributor for additional information.

5.3.1 Intensity, Voltage, and Current Output Range

The intensity range and voltage output range for each lamp (channels 1 to 4) may be user-adjusted, allowing the Multibrite® to interface with a wide range of process control and monitoring equipment. Switches (S1, S2, S3, and S4 corresponding to UV channels 1 to 4) are located inside the enclosure. Each switch may be placed in one of three positions. Table 8 specifies the intensity range, voltage output range, and current output range for each position.

Table 8: Multibrite® Intensity, Voltage, and Current Output Range

Switch Position	Intensity Range	Voltage Output Range	Current Output Range
1	0 – 100%	0 – 10 V	4 – 20 mA
2	0 – 200%	0 – 10 V	4 – 20 mA
3	0 – 100%	0 – 5 V	4 – 20 mA

USE ESD (Electro Static Discharge) SAFE PROCEDURES WHEN OPENING THE MULTIBRITE® ASSEMBLY HOUSING.

The Multibrite® is delivered with all four switches in position 1. Follow these instructions to adjust the switches.

- Remove the top and back cover. RESERVE THE SCREWS FOR REINSTALLATION. Figure 42 highlights the screws to be removed.



Figure 42: Multibrite® Top and Back Cover Screws

- Use the screwdriver adjustment tool provided in the accessory kit to adjust switches S1 (channel 1), S2 (channel 2), S3 (channel 3), or S4 (channel 4) to positions 1, 2 or 3 as needed. Figure 43 shows all switches in position 1.

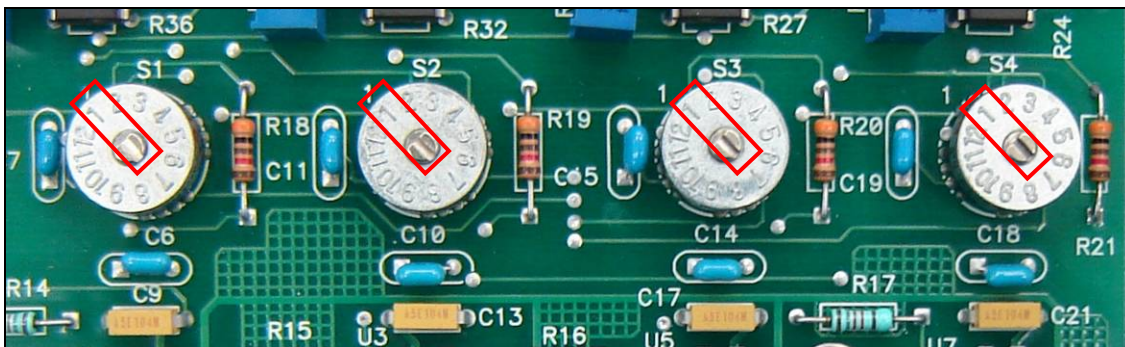

Figure 43: Multibrite® Intensity and Voltage Output Adjustment Switches

- Reinstall the top and back cover.

5.3.2 Time Delay Switch Configuration

The Multibrite® uses a Lamp Power Detection Control to determine when power has been applied to the lamps in the curing system. This control receives signal from the PLC/Control System (See Section 5.4 Multibrite® Wiring). When lamp power is detected, the control initiates a time delay to the alarm circuit to prevent premature low intensity alarms during lamp warm-up. The length of the delay is user-adjustable using the eight Time Delay switches on the back of the Multibrite® (see Figure 44 Multibrite® Back Panel). A switch is “ON” in the up or “1” position and “OFF” in the down or “0” position. Table 9 provides the length of delay in seconds provided by each “ON” switch.

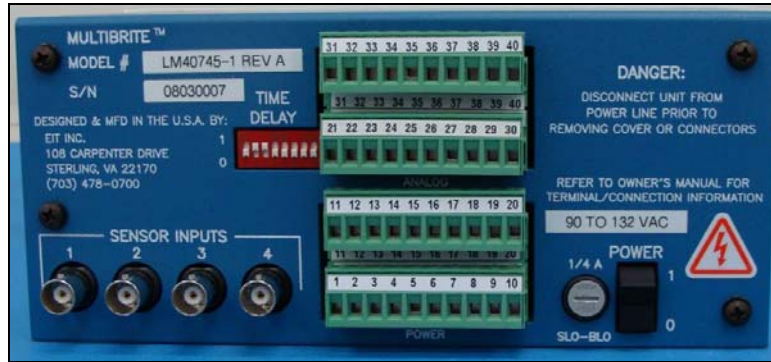

Figure 44: Multibrite® Back Panel

Table 9: Time Delay Switch Values in Seconds							
Switch 1	Switch 2	Switch 3	Switch 4	Switch 5	Switch 6	Switch 7	Switch 8
5	10	20	40	80	160	320	640

The Time Delay switches in Figure 44 show Switches 2 and 3 on and Switches 1, 4, 5, 6, 7, and 8 off. Using the delay values in Table 9, the Low Intensity alarm will be enabled 10 + 20 or 30 seconds after lamp power is detected.

5.3.3 Multibrite® Display Selection

The Multibrite® can display the relative intensity of any of the lamps (channels 1 to 4) or the low intensity threshold setting. Use the switch on the front panel to select lamp 1 (position 1), lamp 2 (position 2), lamp 3 (position 3), lamp 4 (position 4), or the low intensity threshold (Lower Limit position). See section 5.5 to adjust the low intensity threshold. Figure 45 shows Channel 4 selected for display.



Figure 45: Multibrite Front Panel

5.3.4 Audible Alarm

The Multibrite® sounds an audible alarm and lights the Alarm LED when a Low Intensity or Power Alarm condition occurs for any of the four channels. The audible alarm may be disabled by adjusting the Audible Alarm On/Off switch. Figure 45 shows the audible alarm off (down).

5.3.5 Channel Standby

When maintenance is required on a UV lamp, the input channel may be placed in standby mode to prevent inadvertent alarms. Switch any of the Channel On/Off switches in the off (down) position to place them in standby mode. Figure 45 shows all channels in the on (up) position.

If you have questions on Multibrite® configuration, please contact EIT or your local representative/distributor for more information.

5.4 Multibrite® Wiring

WARNING: USE EXTREME CAUTION WHEN WIRING THE MULTIBRITE®. TURN OFF ALL POWER. USE LOCKOUT TAGS TO PREVENT INADVERTANT POWER-UP. SEE FIGURE 3 FOR SAMPLE LOCKOUT TAGS.

The Multibrite® uses four pluggable terminal blocks to connect to power and a PLC or Control System. These terminal blocks are removed for wiring, enclosed in a strain relief shell, labeled, and reinserted into the Multibrite® mating connectors.

If you have any questions on Multibrite® wiring, please contact EIT or your local distributor for additional information.

5.4.1 Terminal Block 1

The terminals in Block 1 receive 24V AC or DC signals from a PLC or Control System. Signal is required on terminals 1 and 2 to make the Multibrite® operational and to enable the Multibrite® alarm detection circuitry. Power received on terminals 3 through 10 disables channels 1 through 4 for Multibrite® systems that are not using all four channels. Wiring for the MB100AC1 and MB240AC1 models is identical.

Table 10 provides a description of the Block 1 terminals.

Terminal #	Description	Optional / Required	Use
1	24V Lamp Power Detection Input	Required	Enable Multibrite® System operation. Initiate alarm delay timer when curing lamps are powered on. Trigger Lamp Power Detection Alarm when power is interrupted.
2	24V Lamp Power Detection Input	Required	Enable Multibrite® System operation. Initiate alarm delay timer when curing lamps are powered on. Trigger Lamp Power Detection Alarm when power is interrupted.
3	Channel 1 24V Power Input	Optional	Disable channel 1 through PLC/Control System

Table 10: Multibrite® Terminal Block 1			
Terminal #	Description	Optional / Required	Use
4	Channel 1 24V Power Input	Optional	Disable channel 1 through PLC/Control System
5	Channel 2 24V Power Input	Optional	Disable channel 2 through PLC/Control System
6	Channel 2 24V Power Input	Optional	Disable channel 2 through PLC/Control System
7	Channel 3 24V Power Input	Optional	Disable channel 3 through PLC/Control System
8	Channel 3 24V Power Input	Optional	Disable channel 3 through PLC/Control System
9	Channel 4 24V Power Input	Optional	Disable channel 4 through PLC/Control System
10	Channel 4 24V Power Input	Optional	Disable channel 4 through PLC/Control System

Lamp Power Detection (Required)

Connect the AC or DC power input from the PLC or Control System with Lamp Detection capabilities to the Multibrite® as follows.

- 24V Lamp Power Detection input at terminal 1
- 24V Lamp Power Detection input at terminal 2

Channels 1 – 4 24V Power Input (Optional)

Power from the PLC/Control System may be used to disable a channel from the Multibrite® System. When the channel is disabled, the relative intensity is not monitored for Low Intensity or Lamp Failure alarms.

To disable Channel 1, connect the PLC/Control System to the Multibrite® as follows:

- 24V Power Input at terminal 3
- 24V Power Input at terminal 4

To disable channel 2, connect the PLC/Control System to the Multibrite® as follows:

- 24V Power Input at terminal 5
- 24V Power Input at terminal 6

To disable Channel 3, connect the PLC/Control System to the Multibrite® as follows:

- 24V Power Input at terminal 7
- 24V Power Input at terminal 8

To disable Channel 4, connect the PLC/Control System to the Multibrite® as follows:

- 24V Power Input at terminal 9
- 24V Power Input at terminal 10

5.4.2 Terminal Block 2

Block 2 contains the terminals used to power on the Multibrite® and to output low intensity and power failure alarm signals to the PLC/Control System or external alarm device. Power on requirements for the MB100AC1 and MB240AC1 models are:

- MB100AC1: 90 to 132 Volts AC, 47 to 440 HZ, 0.20 Amperes
- MB240AC1: 180 to 264 Volts AC, 47 to 440 HZ, 0.20 Amperes

To successfully use the Multibrite® low intensity and lamp power alarm signals, the PLC/Control System or external alarm device must operate within the following parameters:

- Voltage less than 125V AC with a resistive load less than 0.5 Amperes
- Voltage less than 110V DC with a resistive load less than 0.3 Amperes

Table 11 provides a description of each terminal in Block 2.

Table 11: Multibrite® Terminal Block 2			
Terminal #	Description	Optional / Required	Use
11	AC Power Line 1 (L1)	Required	Connect Multibrite® to 110 or 220 AC Power
12	AC Power Line 2 (L2)	Required	Connect Multibrite® to 110 or 220 AC Power
13	AC Power Ground	Required	Ground connection to 110 or 220 AC Power
14	Not Used	Not Used	Not Used
15	Low Intensity Alarm Normally Open (NO) Contact	Optional	Used when PLC or Control System provides low intensity alarm response.
16	Low Intensity Alarm Common	Optional	Used when PLC or Control System provides low intensity alarm response.
17	Low Intensity Alarm Normally Closed (NC) Contact	Optional	Used when PLC or Control System provides low intensity alarm response.
18	Lamp Power Alarm Normally Open (NO) Contact	Optional	Used when PLC or Control System provides lamp failure alarm response.
19	Lamp Power Alarm Common	Optional	Used when PLC or Control System provides lamp failure alarm response.
20	Lamp Power Alarm Normally Closed (NC) Contact	Optional	Used when PLC or Control System provides lamp failure alarm response.

AC Power (Required)

Wiring for the MB100AC1 and MB240AC1 power supply is identical. Connect the power source to the Multibrite® as follows.

- AC Power Line 1 at terminal 11
- AC Power Line 2 at terminal 12
- AC Power Common at terminal 13

Low Intensity and Lamp Power Detection Alarm Relays (Optional)

The Multibrite® provides two alarm relays to monitor Low Lamp Intensity and Power Failure. The UV intensity from the 1 to 4 lamps is compared to a common low level threshold. The Low Intensity Alarm relay is activated when any of the intensity signals (lamps 1 to 4) drops below the threshold. The Lamp Power Detection Alarm is activated when power to the Multibrite® or power to the 1 to 4 UV lamps is disrupted. When either alarm is activated, the Multibrite® Alarm LED turns red and an audible alarm sounds. See section 5.3.4 to disable the audible alarm. Connect the following terminals to the PLC/Control System or external alarm device as follows:

- Low Intensity Alarm Normally Open (NO) Contact at terminal 15
- Low Intensity Alarm Common at terminal 16
- Low Intensity Alarm Normally Closed (NC) Contact at terminal 17
- Lamp Power Detection Normally Open (NO) Contact at terminal 18
- Lamp Power Detection Common at terminal 19
- Lamp Power Detection Normally Closed (NC) Contact at terminal 20

Integrate Low Intensity and Lamp Power Alarms (Optional)

To determine that an alarm condition exists because of a power failure rather than a lamp failure, the Low Intensity Alarm may be disabled when the Lamp Power Detection relay indicates a loss of lamp power. In this case, the two relays are wired in series as follows:

- Low Intensity Alarm Normally Open (NO) Contact at terminal 15
- Low Intensity Alarm Normally Closed (NC) Contact at terminal 17
- Lamp Power Alarm Common at terminal 19
- Lamp Power Alarm Normally Closed (NC) Contact at terminal 20
- Connect the Low intensity Alarm Common (terminal 16) to the Lamp Power Detection Alarm Normally Open Contact (terminal 18) using jumper wire.

Figure 46 illustrates this configuration.

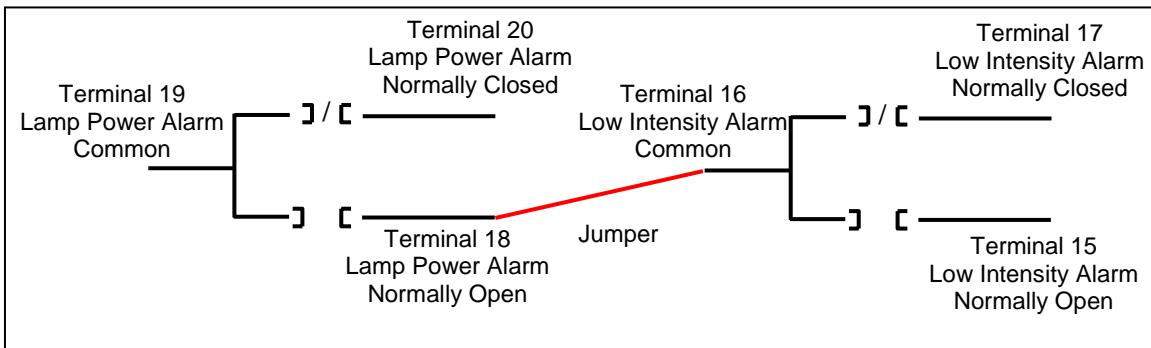

Figure 46: Multibrite® Integrated Alarm Configuration

Multiple Multibrites® with a Common Alarm

To connect a second Multibrite® for a common alarm configuration, connect terminal 18 from the second Multibrite® to terminal 18 of the first Multibrite®.

5.4.3 Terminal Block 3

The Multibrite® uses an external 24V AC or DC power supply to transmit a continuous 4 – 20 mA analog current loop for each of the system's active channels (1 – 4). Signal strength is relative to the intensity of the observed lamps and is capable of driving resistive loads up to 250 Ohms. If the relative intensity is at peak conditions (display shows 100%), the current output is 20mA. When the relative intensity is 0%, the current output is 4mA. See section 5.3.1 for information relating to intensity range configuration.

Table 12 provides a description of the Block 3 terminals and Figure 47 provides a Block 3 wiring diagram.

Table 12: Multibrite® Terminal Block 3			
Terminal #	Description	Optional / Required	Use
21	Channel 1 Current Output (mA) +	Optional	Output Channel 1 4-20mA signal to PLC/Control System
22	Channel 1 Current Output (mA) -	Optional	Output Channel 1 4-20mA signal to PLC/Control System
23	Channel 2 Current Output (mA) +	Optional	Output Channel 2 4-20mA signal to PLC/Control System

Table 12: Multibrite® Terminal Block 3			
Terminal #	Description	Optional / Required	Use
24	Channel 2 Current Output (mA) -	Optional	Output Channel 2 4-20mA signal to PLC/Control System
25	Channel 3 Current Output (mA) +	Optional	Output Channel 3 4-20mA signal to PLC/Control System
26	Channel 3 Current Output (mA) -	Optional	Output Channel 3 4-20mA signal to PLC/Control System
27	Channel 4 Current Output (mA) +	Optional	Output Channel 4 4-20mA signal to PLC/Control System
28	Channel 4 Current Output (mA) -	Optional	Output Channel 4 4-20mA signal to PLC/Control System
29	Local Loop Power Supply +	Required	Connect to 24V Power Source
30	Local Loop Power Supply +	Required	Connect to 24V Power Source

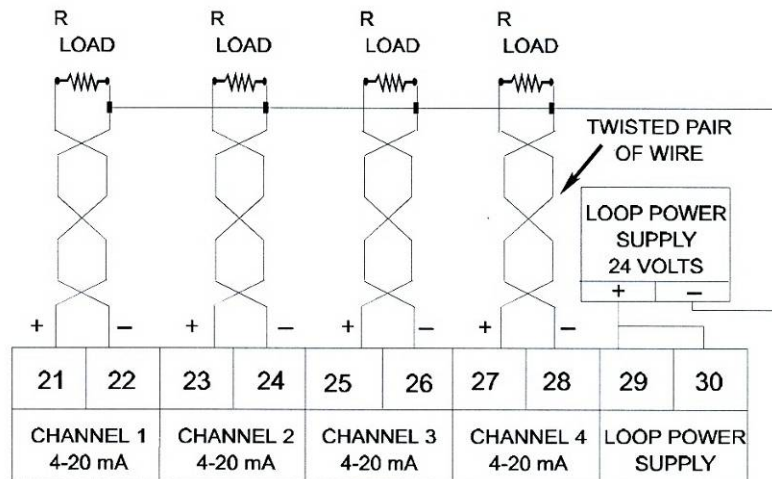

Figure 47: Terminal Block 3 Wiring Diagram

Twisted pair cables should be used to connect the Terminal Block 3 terminals to the PLC/Control System. Wiring for the MB100AC1 and MB240AC1 models is identical.

Channels 1 – 4 Current Output (Optional)

Connections to channels 1 through 4 are noted as optional, but at least one of the four channels must be active.

Connect Channel 1 of the Multibrite® to the PLC/Control System as follows:

- Channel 1 Input (+) at terminal 21
- Channel 1 Output (-) at terminal 22 and Loop Power Supply Output (-)

Connect Channel 2 of the Multibrite® to the PLC/Control System as follows:

- Channel 2 Input (+) at terminal 23
- Channel 2 Output (-) at terminal 24 and Loop Power Supply Output (-)

Connect Channel 3 of the Multibrite® to the PLC/Control System as follows:

- Channel 3 Input (+) at terminal 25
- Channel 3 Output (-) at terminal 26 and Loop Power Supply Output (-)

Connect Channel 4 of the Multibrite® to the PLC/Control System as follows:

- Channel 4 Input (+) at terminal 27
- Channel 4 Output (-) at terminal 28 and Loop Power Supply Output (-)

Loop Power Supply (Required)

Connect the Multibrite® to a PLC/Control System or battery as follows:

- PLC/Control System or battery power input (+) at terminals 29 and 30.

5.4.4 Terminal Block 4

The Multibrite® provides a continuous 0 – 10 Volt analog output for each of the system's active channels. Voltage output is relative to the intensity of the observed lamps and is capable of driving resistive loads greater than 10K Ohms (10V output option) or 5K Ohms (5V output option). If the relative intensity is at peak conditions (100%), the voltage output is 10V or 5V. When the relative intensity is 0%, the voltage output is 0V. See section 5.3.1 for information relating to intensity range and voltage output range configuration.

Table 13 provides a description of the Block 4 terminals and Figure 48 provides a Block 4 wiring diagram.

Table 13: Multibrite® Terminal Block 4			
Terminal #	Description	Optional / Required	Use
31	Channel 1 Voltage Output (+)	Optional	Output Channel 1 0 – 10V signal to PLC/Control System
32	Channel 1 Voltage Output (-)	Optional	Output Channel 1 0 – 10V signal to PLC/Control System
33	Channel 1 and Channel 2 Ground	Optional	Connect Channel 1 and/or Channel 2 ground to PLC/Control System
34	Channel 2 Voltage Output (+)	Optional	Output Channel 2 0 – 10V signal to PLC/Control System
35	Channel 2 Voltage Output (-)	Optional	Output Channel 2 0 – 10V signal to PLC/Control System
36	Channel 3 Voltage Output (+)	Optional	Output Channel 3 0 – 10V signal to PLC/Control System
37	Channel 3 Voltage Output (-)	Optional	Output Channel 3 0 – 10V signal to PLC/Control System
38	Channel 3 and Channel 4 Ground	Optional	Connect Channel 3 and/or Channel 4 ground to PLC/Control System
39	Channel 4 Voltage Output (+)	Optional	Output Channel 4 (lamp 4) 0 – 10V signal to PLC/Control System
40	Channel 4 Voltage Output (-)	Optional	Output Channel 4 (lamp 4) 0 – 10V signal to PLC/Control System

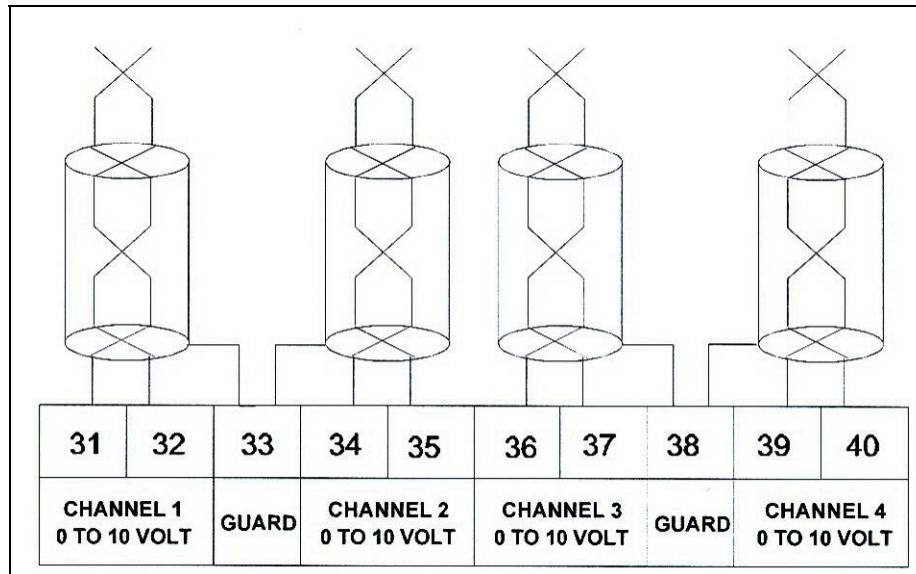

Figure 48: Terminal Block 4 Wiring Diagram

Twisted pair shielded cables should be used to connect the Terminal Block 4 terminals to the PLC/Control System. Wiring for the MB100AC1 and MB240AC1 models is identical.

Voltage Output (Optional)

Connections to channels 1 through 4 are noted as optional, but one of the four channels must be active.

Connect Channel 1 of the Multibrite® to the PLC/Control System as follows:

- Channel 1 Input (+) at terminal 31
- Channel 1 Output (-) at terminal 32
- Channel 1 Ground at terminal 33

Connect the Channel 2 of the Multibrite® to the PLC/Control System as follows:

- Channel 2 Ground at terminal 33
- Channel 2 Input (+) at terminal 34
- Channel 2 Output (-) at terminal 35

Connect channel 3 of the Multibrite® to the PLC/Control System as follows:

- Channel 3 Input (+) at terminal 36
- Channel 3 Output (-) at terminal 37
- Channel 3 Ground at terminal 38

Connect Channel 4 of the Multibrite® to the PLC/Control System as follows:

- Channel 4 Ground at terminal 38
- Channel 4 Input (+) at terminal 39
- Channel 4 Output (-) at terminal 40

5.4.5 Install Terminal Blocks in Strain Relief Shells

Four strain relief kits are provided in the Multibrite® Hardware Kit. Each Strain Relief Kit has a top and a bottom shell, a strain relief clamp, two flat head screws, and a Strain Relief Shield. Follow these steps to install each terminal block into a Strain Relief Shell.

- Fit each terminal block into the bottom half of a strain relief shell as shown in Figure 49.
- Secure the terminal block wires to the bottom shell with the Strain Relief Clamp and two Flat Head Screws as shown in Figure 50.

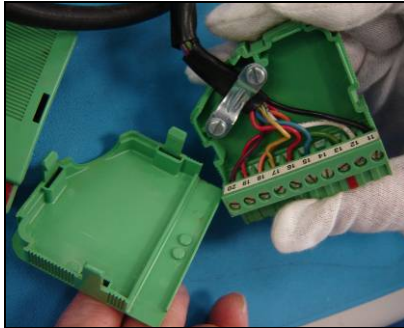

Figure 49: Terminal Block in Strain Relief Shell

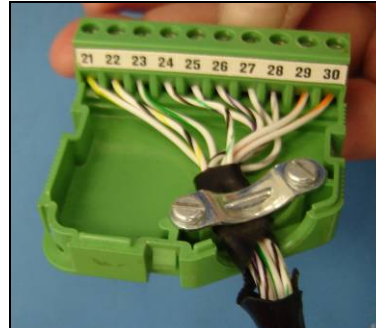

Figure 50: Strain Relief Clamp

- Fit the Strain Relief Shell top onto the bottom as shown in Figure 51.
- The top snaps into place.
- Once the Strain Relief Shell is closed, install the Strain Relief Shield as shown in Figure 52 to prevent the top and bottom from separating.



Figure 51: Strain Relief Shell Top



Figure 52: Strain Relief Shell with Shield

- Identify each terminal block by writing the block number on the Strain Relief Shells as shown in Figure 53.



Figure 53: Labeled Strain Relief Shells

5.4.6 Install Terminal Blocks

Reconnect the terminal blocks to the Multibrite®. Match the terminal block to the mating connectors at the back of the Multibrite® (See Figure 54). Verify the following:

- Terminal Block 1 is connected to terminals 1 through 10. This is the bottom connector on the Multibrite®.
- Terminal Block 2 is connected to terminals 11 through 20. This connector is located second from the bottom.
- Terminal Block 3 is connected to terminals 21 through 30. This connector is located second from the top.
- Terminal Block 4 is connected to terminals 31 through 40. This connector is the top connector on the Multibrite®.



Figure 54: Multibrite® with Compact Sensors™ and Terminal Blocks

5.4.7 Connect Compact Sensors™

Figure 44 shows four sensor input connectors on the back of the Multibrite®. These connectors are used to link the Compact Sensors™ to the Multibrite®. Sensor Input 1 relates to channel 1. Similarly, Sensor Input 2 through 4 relates to channels 2 through 4. Follow these steps to install the Compact Sensors.

- Label each Compact Sensor™ with the appropriate channel number. See Figure 55 as an example.



Figure 55: Compact Sensors™ Labeled with Channel Numbers

- Connect each Compact Sensor™ to the correct Sensor Input as shown in Figure 54.

5.5 Multibrite® Setup

After the Multibrite® is installed and wired correctly, the baseline UV intensity for each channel (most often 100%) and the Alarm Threshold (process dependent) are set. Follow the Equipment Setup procedure before adjusting the UV Intensity Baselines or setting the Alarm Threshold.

5.5.1 Equipment Setup

FOLLOW THESE STEPS BEFORE SETTING THE BASELINE INTENSITY OR ALARM THRESHOLD:

- Replace the existing UV lamps with new lamps and clean the reflectors. This allows the Compact Sensors™ to observe 100% UV output.
- Turn on power to the UV lamps, PLC/Control System, and the Multibrite®.
- Allow the UV lamps to warm up and stabilize for 15 to 30 minutes.

5.5.2 Adjust UV Intensity Baseline

To establish the baseline setting, follow these steps:



- Turn the Display Selector switch to select the first active channel. Figure 56 shows channel 1 selected.
- Make sure that the Channel On/Off switch for the selected channel is in the on (up) position. Figure 56 shows all four channels in the on (up) position.

Figure 56: Display Selection for Channel 1

- Use the screwdriver adjustment tool from the Hardware Kit to adjust the channel's Calibrate POT until the display reads 100% for the channel. Figure 57 shows adjusting the channel 1 Calibrate POT.
- The Multibrite® LCD is capable of displaying 0 – 199 to report power surge or brighter than normal bulbs. Reset the baseline reading as necessary.



Figure 57: Channel 1 100% Baseline Calibrate POT

- Repeat these steps for the remaining channels.

5.5.3 Set Alarm Threshold

The Multibrite® design incorporates noise immunity around the alarm threshold to prevent constant on/off alarm conditions when the relative intensity is near the low level threshold. The alarm is triggered when the intensity drops approximately two points below the threshold and is reset when the intensity increases approximately four points above the threshold. To set the Alarm Threshold, follow these steps.

- Turn the Display Selector switch to select Low Level (LL) as shown in Figure 58.
- Use the screwdriver adjustment tool from the Hardware Kit to adjust the LL Calibrate POT until the display shows the desired Alarm Threshold for your process. The Low Level is set to 70% in Figure 58. At this setting, the alarm will sound when the relative intensity reaches approximately 68 and reset with the relative intensity increases to approximately 74.



Figure 58: Low Level Threshold

Appendix A – EIT UV Bandwidth Definition

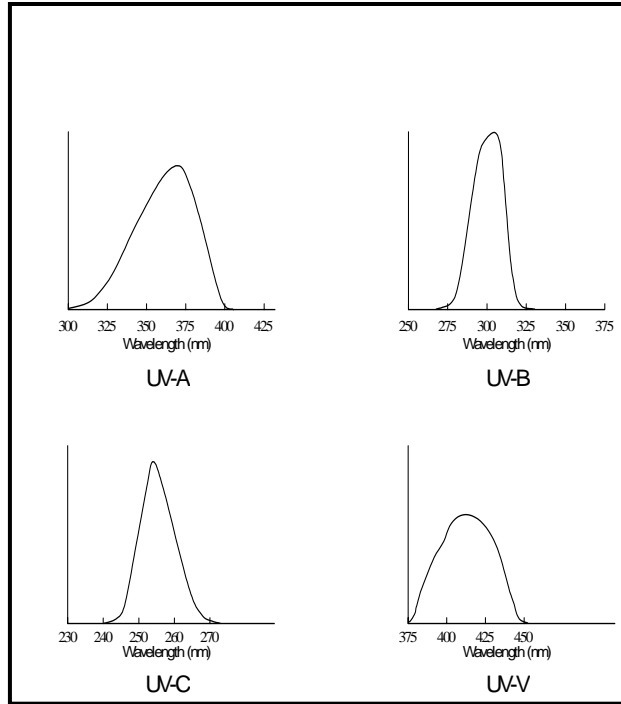

UVA
320-390 nm
CWL
365nm

UVB
280-320 nm
CWL
313nm

UVC
250-260 nm
CWL
254nm

UVV
390-445 nm
CWL
405nm

Appendix B – Compact Sensor™ Technical Specifications

Dimensions	CS-1 Type 0.57" x 1.10" x 0.75" / 1.45 x 2.78 x 1.91 cm CS-2 Type 0.57" x 0.60" x 0.75" / 1.45 x 1.52 x 1.91 cm
UV Bandwidth	UVA 320 – 290nm UVB 280 – 320nm UVC 250 – 260nm UVV 390 – 445nm
Angle of View	CS-1 Type +/- 5° CS-2 Type +/- 13°
Housing Material	Aluminum
Weight	CS-1 Type 0.8 oz / 22.68 g CS-2 Type 0.7oz / 19.86 g
Cable	CSC1A-10 (10' Teflon shielded cable with BNC Male Connector). Used with Online UV Intensity Display Module™ or Multibrite® CSC1A-X (Custom length Teflon shielded cable with BNC Male Connector). Used with Online UV Intensity Display Module™ or Multibrite® CSC1B-10 (10' Teflon shielded cable with Molex Connector and Tinned Leads). Used with DIN Rail UV Intensity Monitor™. CSC1B-X (Custom length Teflon shielded cable with Molex Connector and Tinned Leads). Used with DIN Rail UV Intensity Monitor™. CSC1D-X (Custom length Teflon shielded cable with Molex and CONXALL Male connectors). Used when the cable must fit through a bulkhead or in a system that may be swapped out frequently for maintenance. Molex end connects to Compact Sensor™ CSC4A-X (Custom length Teflon shielded cable with Male BNC and Female CONXALL Connectors). Used with CSC1D-X when installing the cable through a bulkhead and connecting to an Online UV Intensity Display Module™ or a Multibrite® unit. CSC4B-X (Customer length Teflon shielded cable with CONXALL female connector and tinned leads). Used with the CSC1D-X when installing the cable through a bulkhead and connecting to a DIN Rail UV Intensity Monitor™ CSC3A-X (Customer length Teflon shielded cable with BNC Female and BNC Male Connectors). Extension cable for CSC1A-10 or CSC1A-X
Operating Temperature	0 - 212° F / 0 – 100° C

Appendix C – DIN Rail UV Intensity Monitor™ Technical Specifications

Power Source	20-28 Volts AC or DC at 70mA maximum
Output	0-10 Volt DC – proportional to UV Intensity
Accuracy	Intensity: +/- 3% of full scale (10 volts) Alarm: +/- 5% from threshold
Dimensions	3.11"W x 3.56"H x 9.98" D / 7.90cm x 9.04cm x 2.49cm
Weight	3.6oz / 101 g
Operating Temperature	0 - 122° F / 0 – 50° C

Appendix D – Online UV Intensity Display Module™ Technical Specifications

Power Source	20-28 Volts AC or DC at 500mA maximum
Output	0-10 Volt DC – proportional to UV Intensity; Display indication of 100% = 5V
Accuracy	Intensity: +/- 3% of full scale (10 volts, 200%) Alarm Relay: +/- 5% from threshold
Dimensions	Front Plate 6.5" x 5" / 16.51cm x 12.70cm
Weight	4.60 oz / 115 g
Display Range	0 – 199%
Operating Temperature	0 - 122° F / 0 – 50° C

Appendix E – Multibrite® Technical Specifications

Display	Source selected by turning switch to different channels
Display Range	0 – 199%
Input Power Requirements	MB100AC1: 90 to 132 Volts AC; 47 to 440 HZ, 0.20 Amperes MB240AC1: 180 to 264 Volts AC; 47 to 440 HZ, 0.20 Amperes
Input Current Requirements	0.2 – 2.0 microampere for 100% full scale reading. Adjustable via 20 turn “Calibrate” adjustment
Output Current Range	4 – 20 mA into a maximum impedance of 250 ohms
Output Voltage Range	0 – 10 VDC into a minimum impedance of 10K ohms 0 – 5 VDC into a minimum impedance of 5K ohms
Alarm Outputs	Dry contacts rated for 0.5A at 125 VAC driving a resistive load
Dimensions	Enclosure 7.0”W x 3.5”H x 5.9”D / 17.78 x 8.89 x 14.98cm Front Plate 9.4”W” x 3.5”H” / 23.88cm x 8.89cm
Weight	3 lbs / 1.36 kg
Construction	Painted aluminum with integral mounting flanges
Mounting	Panel mounted (1/2 rack dimensions)
Operating Temperature	0 - 122° F / 0 – 50° C